

MAKE | BUILD | HACK | CREATE

HackSpace

TECHNOLOGY IN YOUR HANDS

hsmag.cc | September 2022 | Issue #58

**Inventor
2040 W**

Wireless dev
board on test

HACK YOUR FOOD

Delicious builds to add fun and
flavour to your cooking

Polystyrene

Build your projects
with packaging

Protoboard

Custom-made
holey PCBs

Sept. 2022
Issue #58 £6

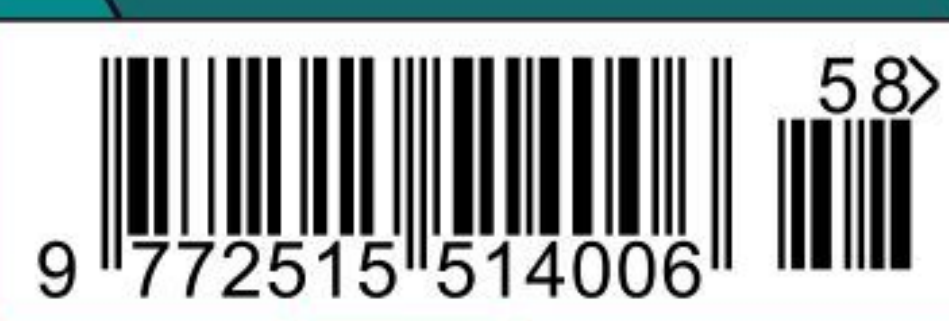

CHOCOLATE SCALPEL HINGES MUSIC

American Raspberry Pi Shop

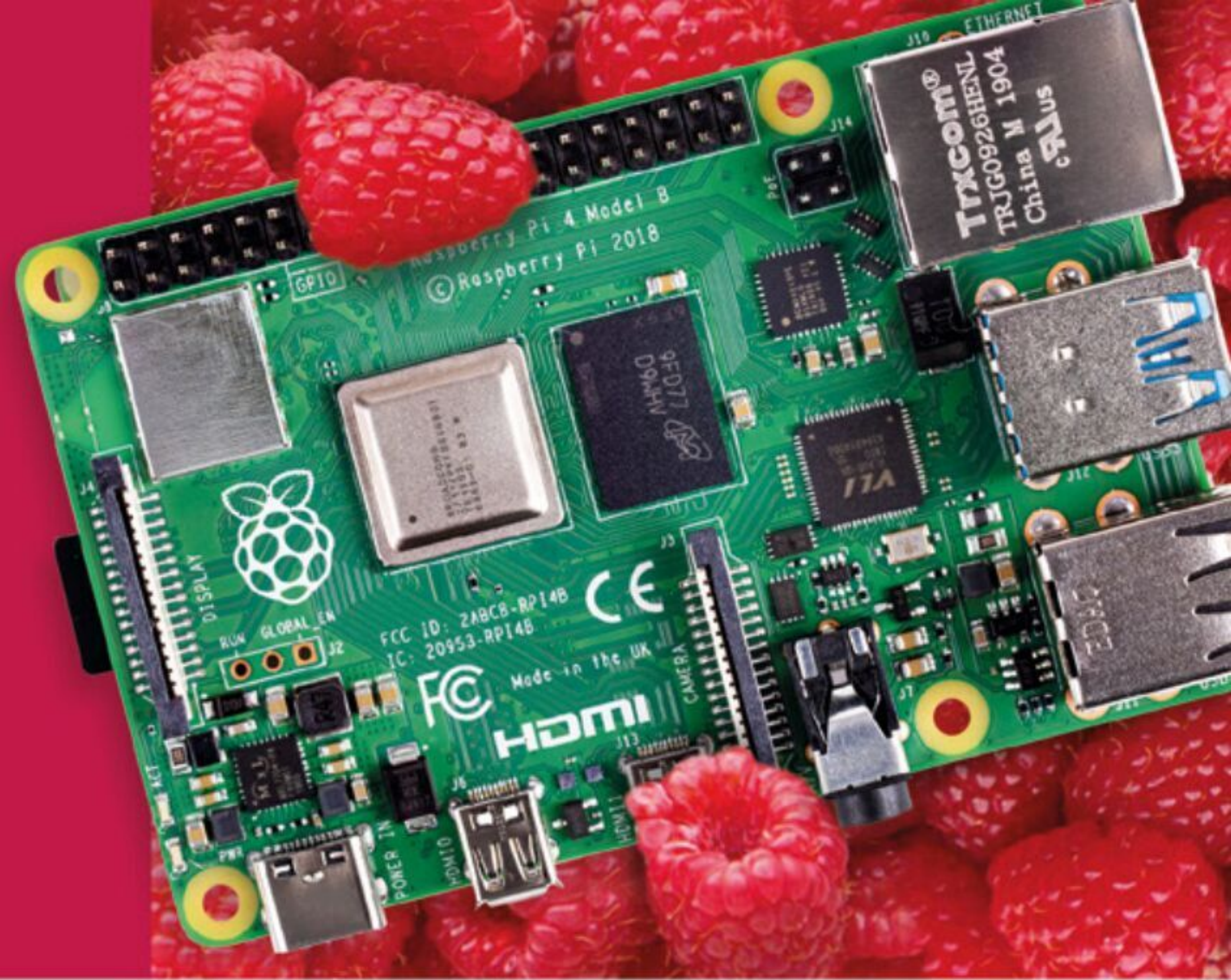

- Displays
- HATs
- Sensors
- Cases
- Arcade
- Swag
- Project Kits
- Cameras
- Power Options
- Add-on Boards
- Cables and Connectors
- GPIO and Prototyping

Partner and official reseller for top Pi brands:



and many others!

Price, service, design,
and logistics support for
VOLUME PROJECTS

USA



PiShop.us

Canada



PiShop.ca

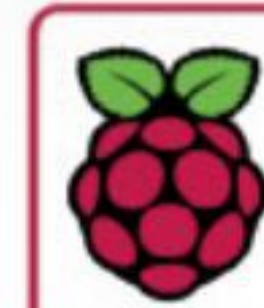

Raspberry Pi

APPROVED RESELLER

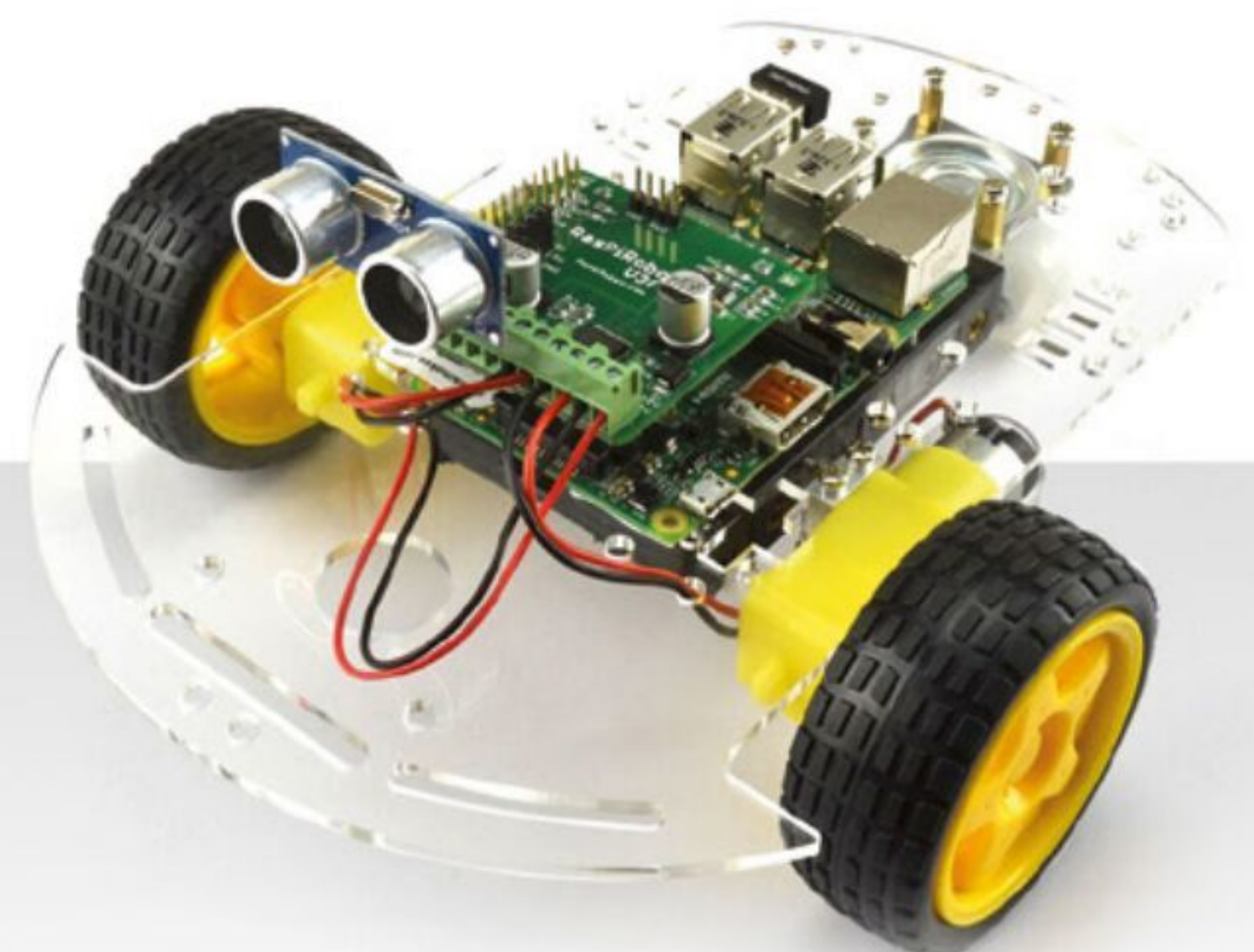



Welcome to HackSpace magazine

Most people eat around 1000 meals a year. Anything you do that frequently is a good candidate for hacking. Spending a little time optimising the time to make food, or the enjoyment you can get from it will pay you back every day. What's more, food offers almost endless possibilities for getting creative, yet conventional kitchens rely on just a few methods. This issue, we're taking a look at how to use your

Spending a little time optimising the time to make food, or the enjoyment you can get from it will pay you back every day

maker skills to make your life a little more delicious.

Of course, it's not all about edible delights, a personal

highlight for me is Jo's article on vinyl cutting. These versatile machines are reasonably cheap and can do a lot, yet are often overlooked by makers. We're also designing PCBs, making music, and much more. Turn the page to get started.

BEN EVERARD

Editor ben.everard@raspberrypi.com

Got a comment, question, or thought about HackSpace magazine?

get in touch at hsmag.cc/hello

GET IN TOUCH

hackspace@raspberrypi.com

[hackspacemag](#)

[hackspacemag](#)

ONLINE

hsmag.cc



PAGE **42**
FREE PICO W
WHEN YOU
SUBSCRIBE

EDITORIAL

Editor

Ben Everard

ben.everard@raspberrypi.com

Features Editor

Andrew Gregory

andrew.gregory@raspberrypi.com

Sub-Editors

David Higgs, Nicola King

DESIGN

Critical Media

criticalmedia.co.uk

Head of Design

Lee Allen

Designers

Sam Ribbits, Olivia Mitchell, Ty Logan

Photography

Brian O'Halloran

CONTRIBUTORS

Jo Hinchliffe, Marc de Vinck, Andrew Lewis, Mike Bedford, Phil King, Rosie Hattersley, Rob Miles

PUBLISHING

Publishing Director

Russell Barnes

russell@raspberrypi.com

Advertising

Charlie Milligan

charlotte.milligan@raspberrypi.com

DISTRIBUTION

Seymour Distribution Ltd

2 East Poultry Ave,

London EC1A 9PT

+44 (0)207 429 4000

SUBSCRIPTIONS

Unit 6, The Enterprise Centre, Kelvin Lane, Manor Royal, Crawley, West Sussex, RH10 9PE

To subscribe

01293 312189

hsmag.cc/subscribe

Subscription queries

hackspace@subscriptionhelpline.co.uk



This magazine is printed on paper sourced from sustainable forests. The printer operates an environmental management system which has been assessed as conforming to ISO 14001.

HackSpace magazine is published by Raspberry Pi Ltd, Maurice Wilkes Building, St. John's Innovation Park, Cowley Road, Cambridge, CB4 0DS. The publisher, editor, and contributors accept no responsibility in respect of any omissions or errors relating to goods, products or services referred to or advertised. Except where otherwise noted, content in this magazine is licensed under a Creative Commons Attribution-NonCommercial-ShareAlike 3.0 Unported (CC BY-NC-SA 3.0). ISSN: 2515-5148.

Contents



06

SPARK

- 06 **Top Projects**
Beautiful things made by beautiful people
- 18 **Objet 3d'art**
A bespoke PC build
- 20 **Letters**
A kindred spirit discovers EMF Camp
- 22 **Crowdfunding**
A helping hand for surface-mount soldering

25

LENS

- 26 **Food hacks**
Don't play with your food: hack it instead!
- 38 **How I Made: Water butt power-up**
Keep thirsty plants happy with tech
- 44 **Interview: Ellie Weinstein**
Meet the Willy Wonka of 3D printing
- 52 **Improviser's Toolbox Polystyrene**
Packing material, insulation, and brilliant making fodder
- 58 **In the Workshop**
Easy modifications for a better mitre saw

38

Cover Feature



Tutorial

Clippy



64

Grip, close, and... bite your open food packaging with 3D-printed clips

06



Tutorial

Double hinges



86 Bend, fold, and impress small children (and large adults)

63 FORGE

64 SoM 3D printing
Keep food fresh with printed clips

68 SoM Raspberry Pi
Build a weather station

72 Tutorial Vinyl cutting
Do more with the trusty vinyl cutter

80 Tutorial Chocolate box synth
Create beats and bleeps with Pure Data

86 Tutorial Double hinges
Is it physics or magic? We say magic

92 Tutorial Protoboard
Create custom shapes

94 Tutorial Prusa Slicer
No STL files? No problem!

98 Tutorial Sublimation printing
Add colour to PCBs



112



72

Interview

Ellie Weinstein



44 Chocolate, meet 3D printing: inside the tech of hot chocolate



80

101 FIELD TEST

102 Best of Breed
The best goodies from Crowd Supply

108 Review
Pimoroni Inventor 2040 W

112 Review
3 Coil Crane folding scalpel

108

Some of the tools and techniques shown in HackSpace Magazine are dangerous unless used with skill, experience and appropriate personal protection equipment. While we attempt to guide the reader, ultimately you are responsible for your own safety and understanding the limits of yourself and your equipment. HackSpace Magazine is intended for an adult audience and some projects may be dangerous for children. Raspberry Pi Ltd does not accept responsibility for any injuries, damage to equipment, or costs incurred from projects, tutorials or suggestions in HackSpace Magazine. Laws and regulations covering many of the topics in HackSpace Magazine are different between countries, and are always subject to change. You are responsible for understanding the requirements in your jurisdiction and ensuring that you comply with them. Some manufacturers place limits on the use of their hardware which some projects or suggestions in HackSpace Magazine may go beyond. It is your responsibility to understand the manufacturer's limits. HackSpace magazine is published monthly by Raspberry Pi Ltd, Maurice Wilkes Building, St. John's Innovation Park, Cowley Road, Cambridge, CB4 0DS, United Kingdom. Publishers Service Associates, 2406 Reach Road, Williamsport, PA, 17701, is the mailing agent for copies distributed in the US. Application to mail at Periodicals prices is pending at Williamsport, PA. Postmaster please send address changes to HackSpace magazine c/o Publishers Service Associates, 2406 Reach Road, Williamsport, PA, 17701.

3D-printed internal combustion engine

By Aseesh Paul Bandaru and Vaishnavi Dabhade hsmag.cc/3DPrintICEngine

As mechanical engineering students, Aseesh Paul Bandaru and Vaishnavi Dabhade needed to demonstrate their skill with CAD to design an object with a series of moving, interlocking parts: an internal combustion engine.

There's a DC motor and a crankshaft to make the engine work, and the whole thing took over 1 kg of filament. More than that – just look at it: it's so clean! ▣

Right ▣
Because of the stresses on the crank-shaft, the makers recommend printing it with a 100% infill



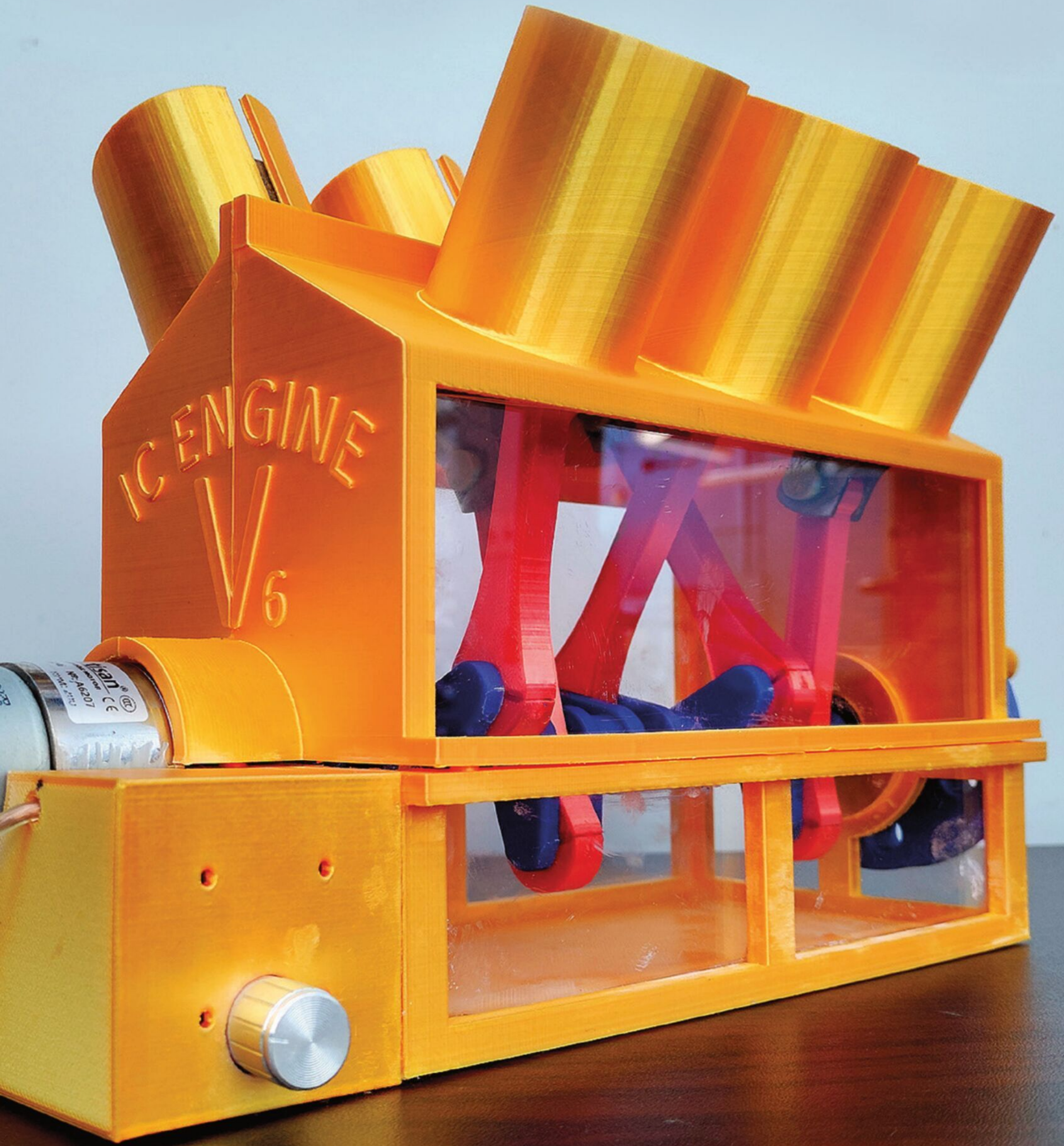

PKE Meter

By Kevin McAleer

hsmag.cc/PKE-Meter

This project really combines a few of our favourite things, with MicroPython, 3D-printed parts, and a load of electronic goodies from Pimoroni: a LiPo Amigo Pro charger, a DS-959MG servo, a Display Pack 2.0 for Pico, a 400mAh battery, and a Pico Proto prototyping board. Oh, and a Raspberry Pi

Pico W.

Just like in the film *Ghostbusters*, the PKE meter raises and lowers its arms as a response to the strength of a nearby signal, though in the case of this build, it's looking for WiFi signal rather than ectoplasmic activity. ▣

Right ▣
Human sacrifice!
Dogs and cats living
together! Mass
hysteria! Decent
WiFi signal!



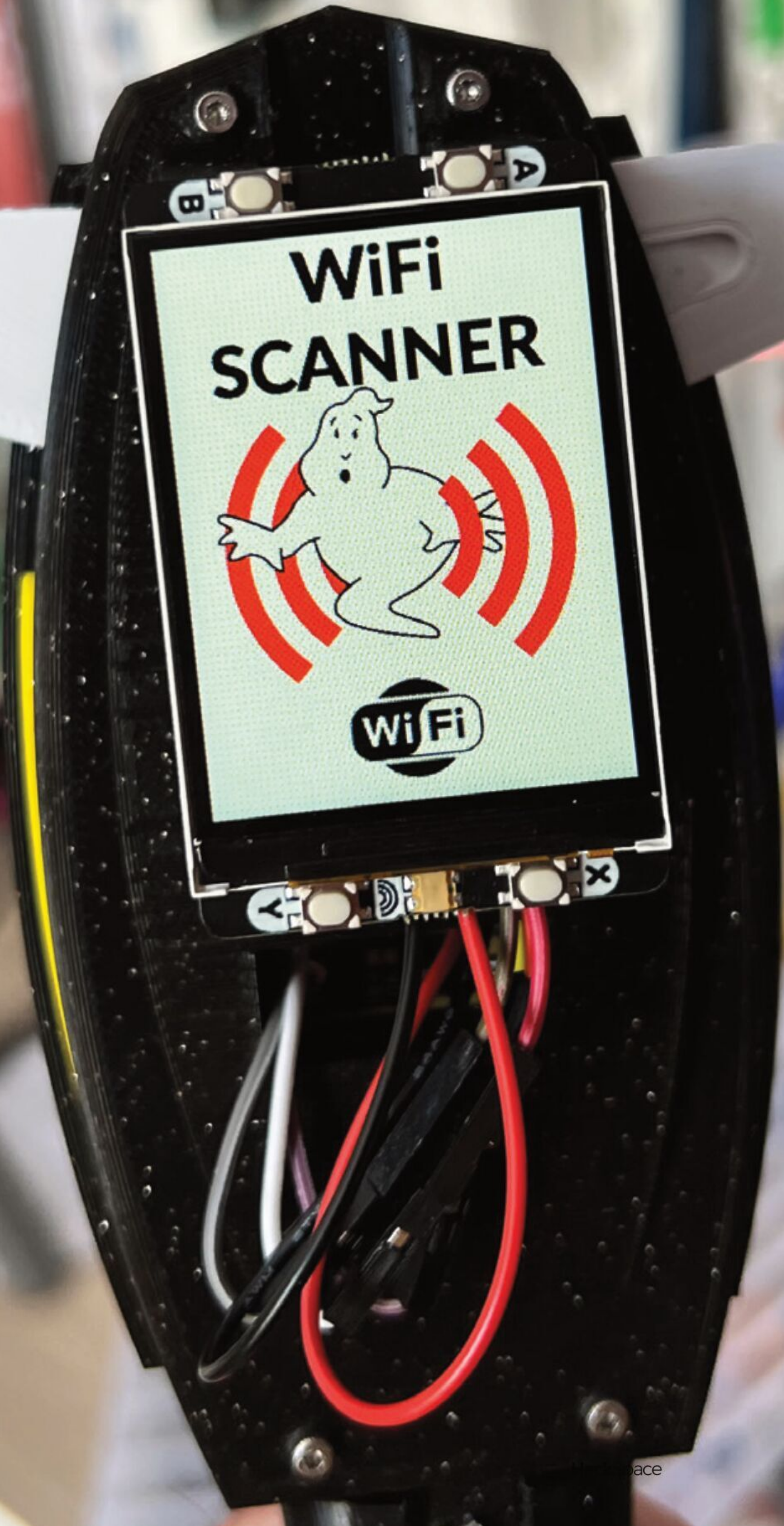

F91 Kepler

By Pegor

hsmag.cc/KeplerCasio

The Casio F-91W is a design classic. It's inspired a few remixes since its release in 1989 (or more accurately, since hardware became cheap and small enough that home tinkerers could replace its innards with something more useful).

The latest maker to turn this classic timepiece into something with more functionality is Pegor, who has replaced the watch's innards with a load of modern equipment, including a Texas Instruments CC2640 Arm Cortex-M3 chip.

Pegor's watch is Bluetooth-capable, has a notification bar, lets the user know when they've got a text, and has a battery life of roughly 15 days.

It's by no means finished – we came across this project because Pegor is burned out from working on it, and is looking for collaborators. If you think you can help, get in touch. [□](#)

Right [□](#)
Pegor's ditched everything about the original Casio F-91W, except for the case



CASIO

F-91W

ALARM CHRONOGRAPH

LIGHT



TEXT FROM
Jon Doe

ALARM ON-OFF/24HR

RESIST

MODE

WR

WATER

DSKY

By Bill Glasford

hsmag.cc/DSKY

W

e'll admit, we first liked this project because of how gloriously retro it looks.

Then we delved a little deeper, and now we love it even more. Bill Glasford has built a functioning replica of the display keyboard (DSKY) used on the Apollo Guidance

Computer, the space-age avionics system used by NASA on its moon-landing equipment between 1966 and 1975.

It's a beautiful build, comprising two LCD screens, a Raspberry Pi, and three Arduinos, and featuring an array of 3D-printed parts. What's more impressive is that it runs the assembly code that the original computer ran all those decades ago. ▣

Right ▣
Bill used the actual NASA documents as a reference for this project

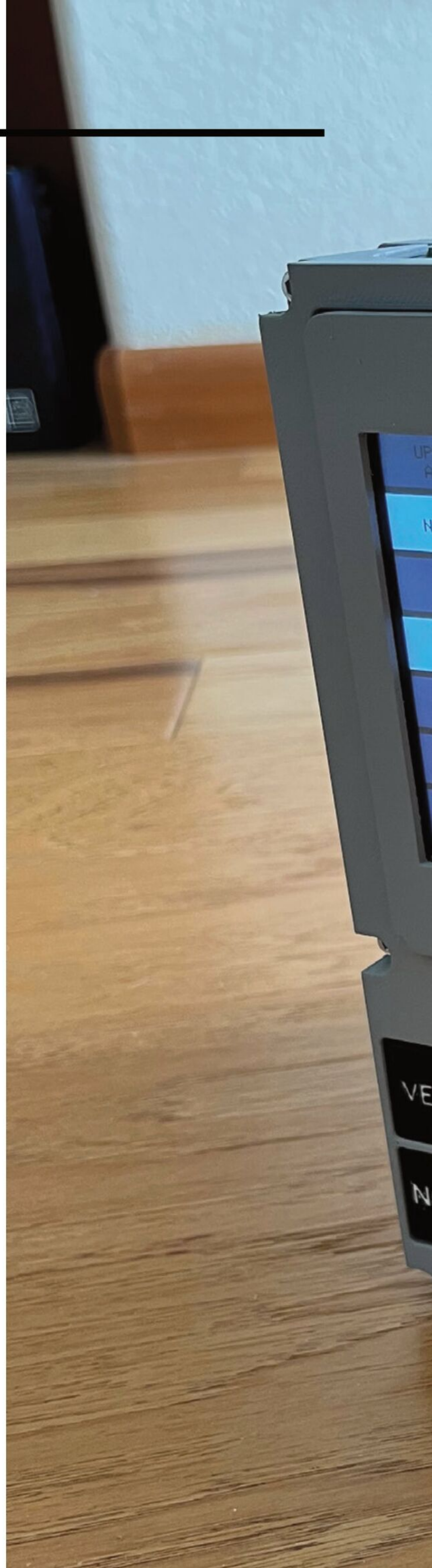

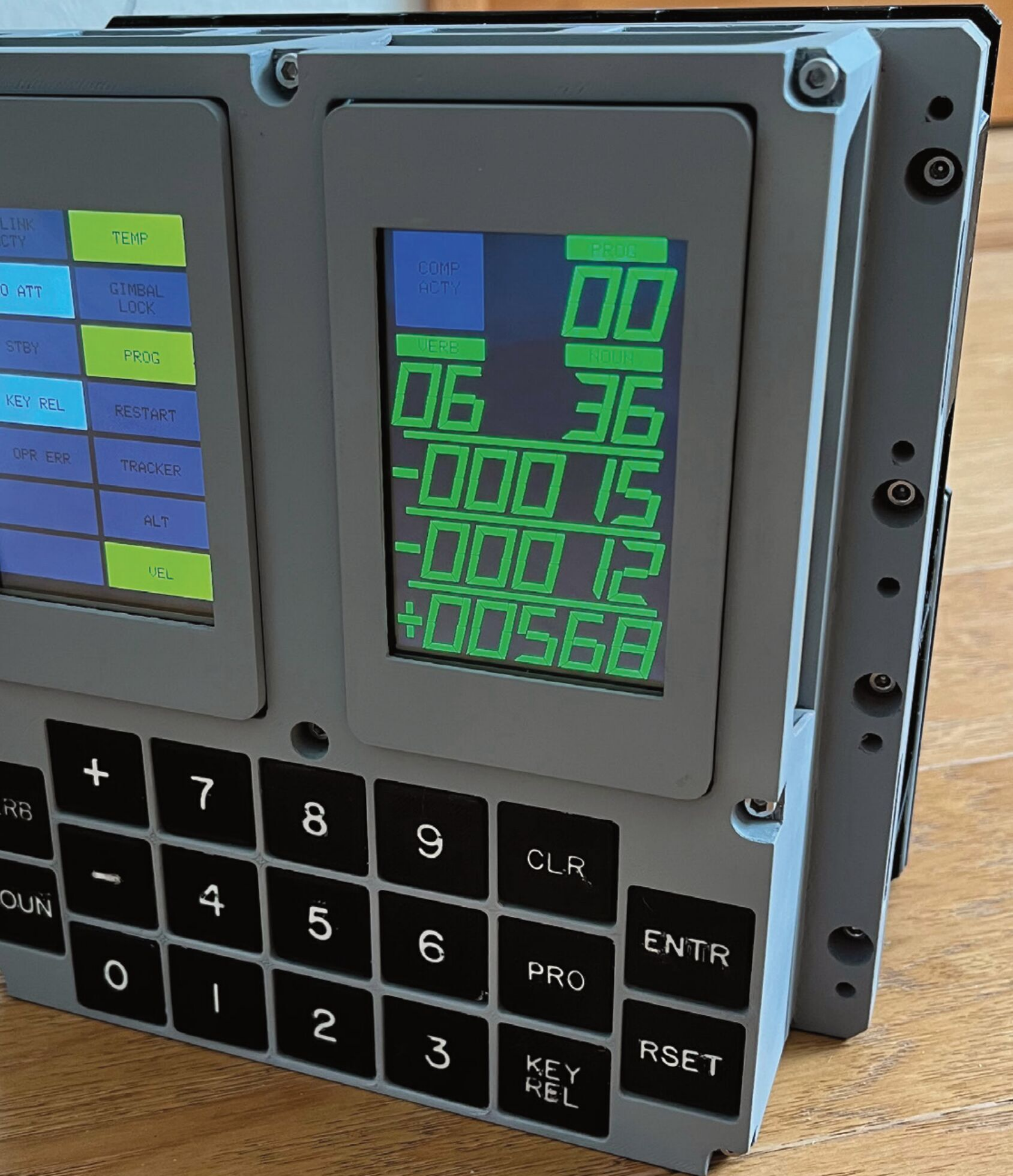

Tabletop arcade unit

By mw33212

hsmag.cc/TableTopArcade

This head-to-head tabletop arcade machine is perfect for those occasions when you need to win at *Street Fighter 2* and see the defeat in your opponent's eyes. It's also how mw33212 used up a load of walnut offcuts that he had after working on other projects.

We'd love to say that the plans are available for all to see, but to quote the maker, "sadly I think you would be a little disappointed by my 'plans', which were basically just lots of Post-it notes with triangles and scribbles on them. I generally have an idea about an overall design, and then just get started." ▣

Right ▣
This incredible build was put together using only hand tools and an electric drill





CONFIGURATION

IN THIS ISSUE OF RETRO GAME

LAUNCH SCREENSAVER MENU RANDOM SELECT CHOOSE

Berlin Uhr Nano

By Julius Oeff

hsmag.cc/BerlinUhrNano

There's a clock in Berlin, on Budapester Strasse near the Kaiser Wilhelm Memorial Church, that's unlike any we've seen anywhere else. Its display shows no numerals, and there are no hands going round; instead there are rows of lights.

Each of the red lights in the first row represents five hours. Each red light in the second row represents one hour. It's a 24-hr clock so, to show 2 o'clock, you'd light up two red lights from the top row and four from the second row, making 14 hours. Each of the lights in the third row represents five minutes, and each of the lights in the fourth row represents one minute.

It's odd and unintuitive to those of us used to thinking of time in multiples of twelve, but it works. This creation by Julius Oeff goes two better, in that it miniaturises the clock into a wearable size, and adds two more rows of LEDs to represent seconds. Ausgezeichnet. ▣

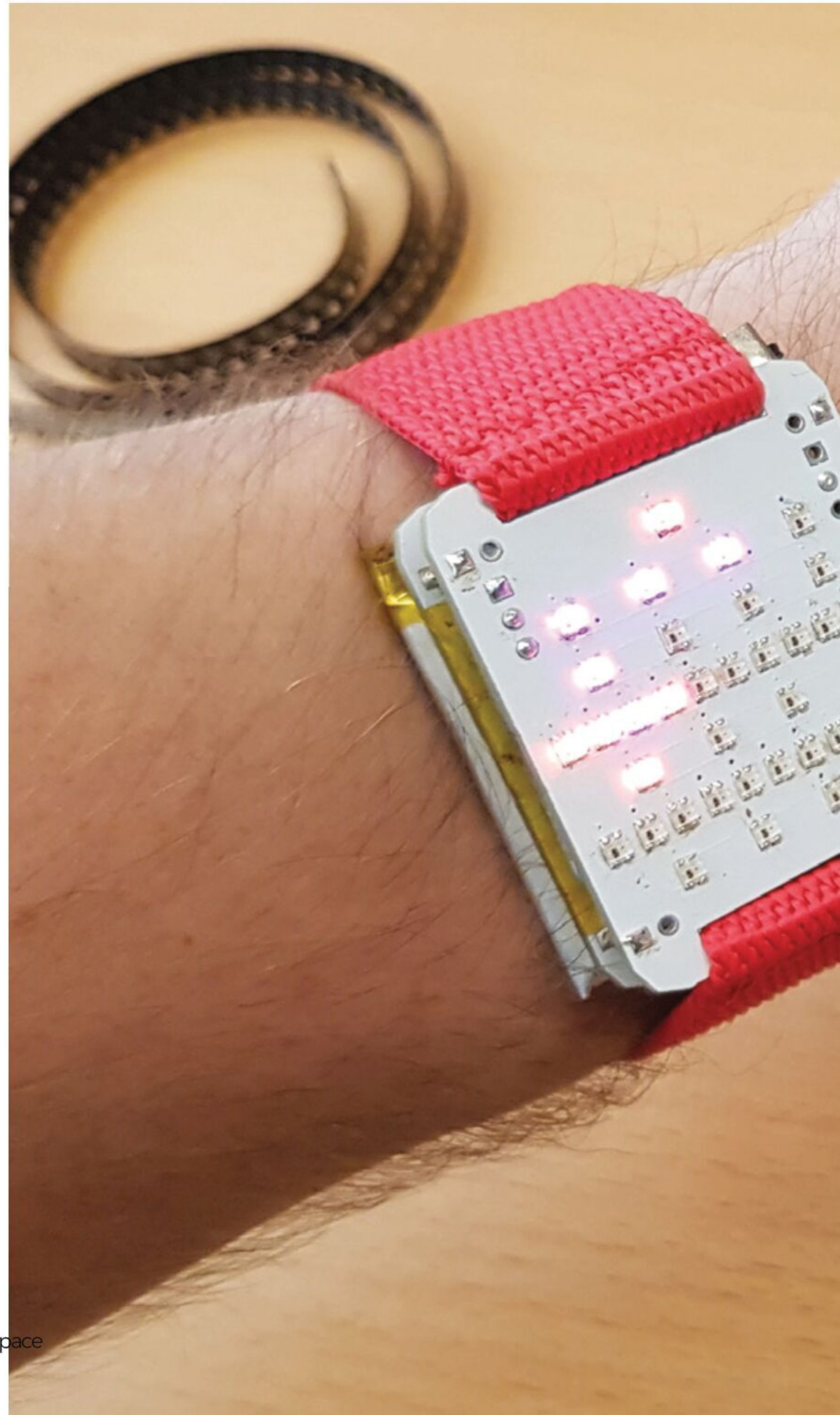

Right ▣
Der Zeit, ihre
Kunst; der Kunst,
ihre Freiheit

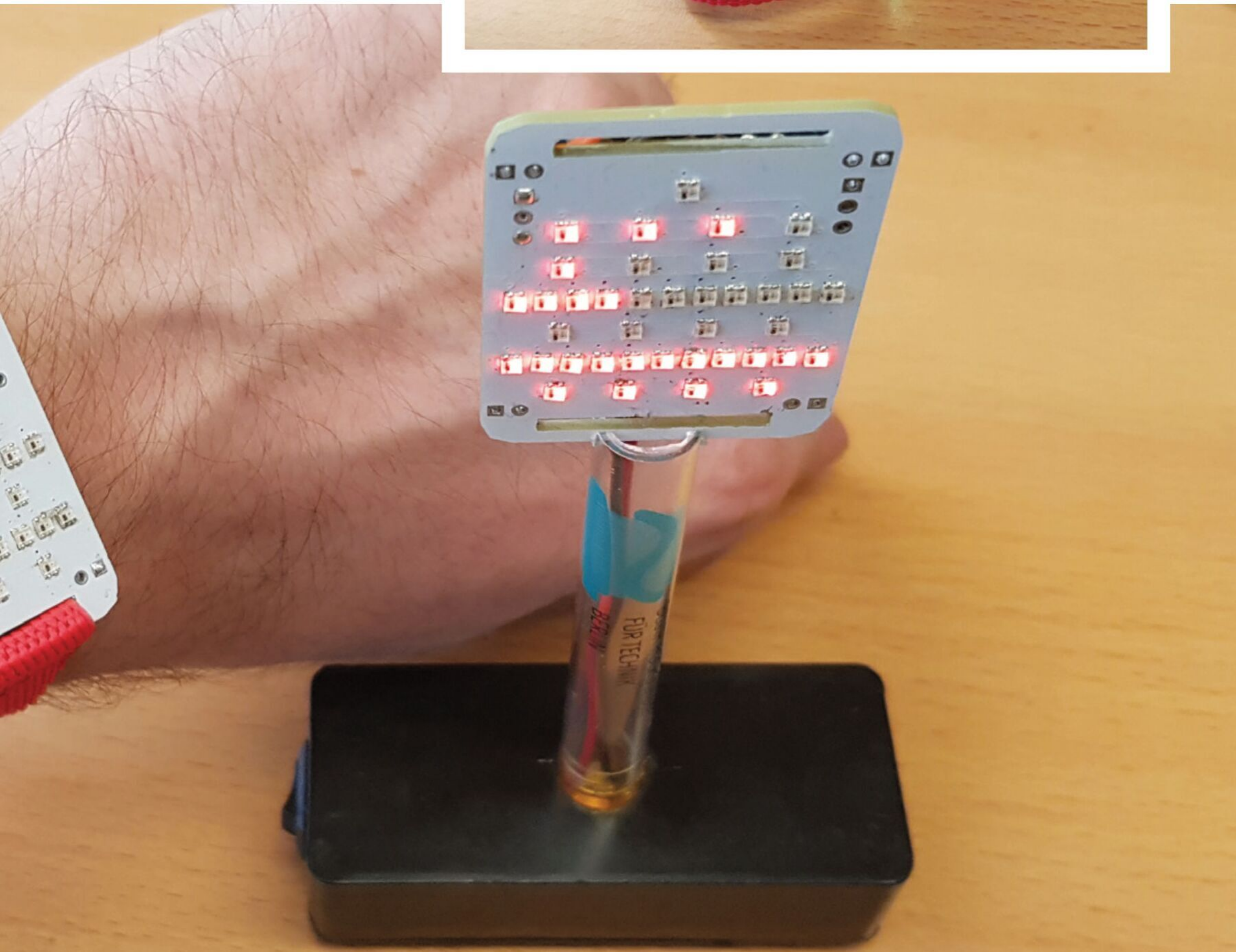

Objet 3d'art

3D-printed artwork to bring more beauty into your life

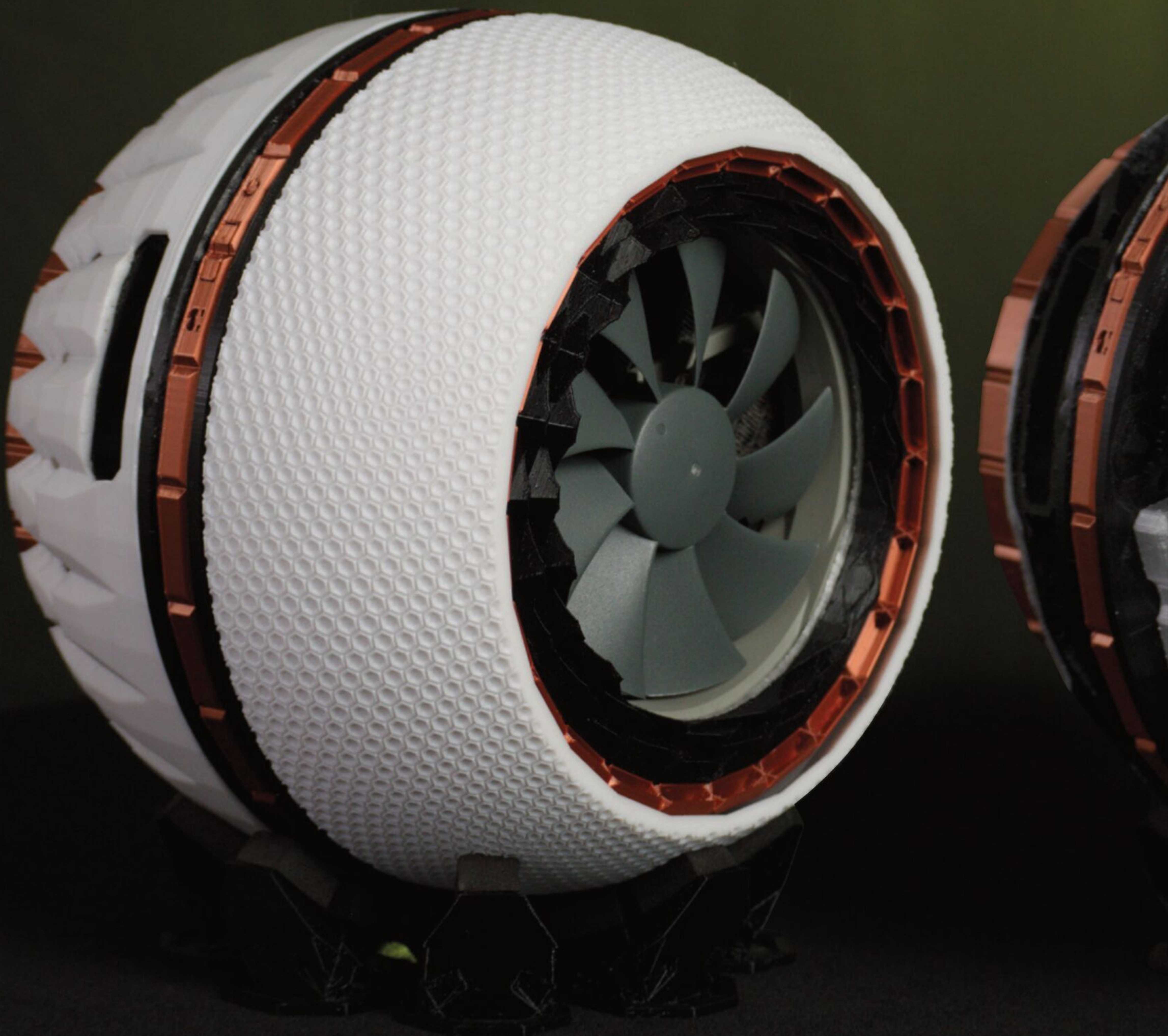

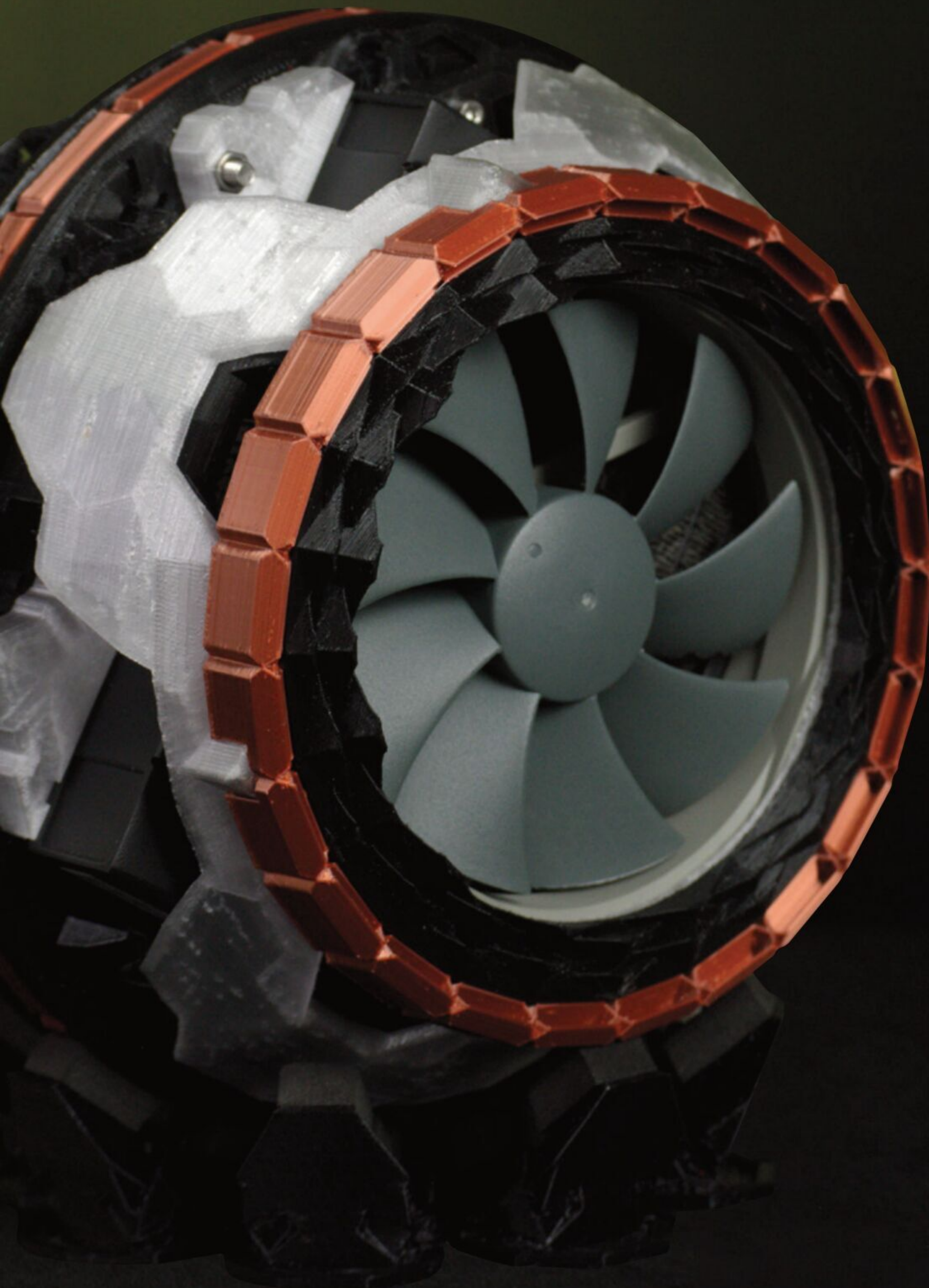

This custom PC was designed in Blender using its Mesh editing and Icosphere functions – that’s impressive enough in itself, as we’re amazed by anyone who can take on the enormous complexity of Blender. Its split sphere design lends it to efficient cooling; that and the big fan on the front.

The builder of this work of art is Jean Roberto De Iacovo, who printed it on his Creality Ender-3 Pro, modified with a quieter mainboard and more efficient fans.

The motherboard is fitted to the chassis using M3 bolts screwed into brass insets, and the copper highlights are printed in GIANTARM Silk Copper Filament. It’s a fascinating build and, what’s more, it houses a fully functional gaming PC; for full details, check out the write-up in Custom PC magazine, issue 228 – and gawp at the video here below. [□](#)

hsmag.cc/Pinasphere

Letters

ATTENTION ALL MAKERS!

If you have something you'd like to get off your chest (or even throw a word of praise in our direction), let us know at hsmag.cc/hello

EMF CAMP

I've just got back from Deer Shed Festival in beautiful North Yorkshire. As well as the music and sunshine, the festival lays on a load of science- and technology-based activities for children. So why, I thought, is there no equivalent for grown-ups? Where's the festival of geekery, camping in a field under the stars, drinking delicious booze, and learning about robotics, or cybersecurity. Or at least, I did until I heard about EMF Camp. Thanks for including it in the magazine last issue, and I'll look out for it coming around next year.

Robert
Harrogate

Ben says: If you're waiting for EMF Camp to come around next year, you may be disappointed: the organisers put it on every two years, global pandemics permitting. Other than that, you're bang on – we grown-ups get a raw deal when it comes to fun science things, and so it's wonderful to see the likes of us catered for by like-minded people for whom technology isn't just a job, it's a form of play too.



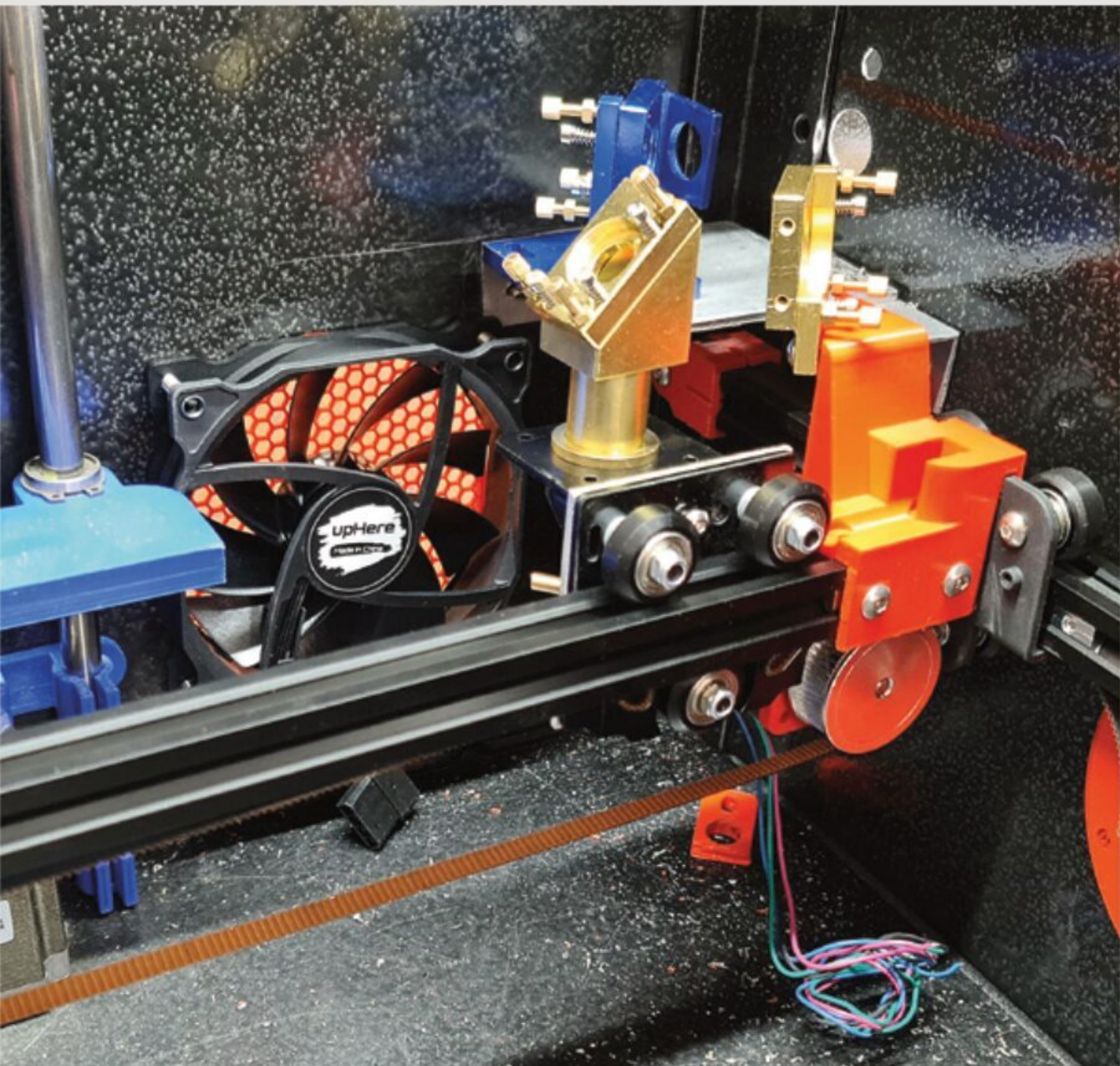

KNITTING

I was interested to read your comparison between knitting and coding last issue – in particular the use of knitting as a means of encoding information about the movement of German troops in the Second World War. It literally is just generating loops, like you do in any programming language, but I'd never put two and two together until I saw it put right in front of me.

Sarah

London

Ben says: There are obvious parallels between the two, which are even more explicit when you think about the Jacquard loom and its relation to computing history. We're even seeing knitting machines hacked with Arduinos, which, for me, makes them far more interesting. Our writer Nicola was so smitten with encoding patterns in fabric that she's working on a tutorial involving using a loom as we speak – look out for it!

LASER CUTTING

Thanks to Andrew Lewis for the exhaustive series on laser cutting – I don't have one but, now that I've read his words of wisdom, I feel like I know what to look for when I do come to splash the cash.

David

Coventry

Ben says: The level of detail that Andrew's gone into has been nothing short of heroic, and it's always left me feeling cleverer after reading them than I was before, which I take as a good sign. The crazy thing is that we didn't even get started using the laser cutter, which we hope to do next issue.



CROWDFUNDING NOW

Pixel Pump

A helping hand for populating PCBs

From \$449 | hsmag.cc/pixelpump | Delivery: Jan 2023



There was a time when building circuit boards involved poking leads through holes and then using a soldering iron to secure these components in place.

While some people still do it this way, many modern boards are 'surface mount', which means placing teeny packages on even tinier blobs of paste, then popping the whole board in an oven to reflow the solder paste and secure the components.

Putting all these tiny components in the right place is, frankly, a right pain. The Pixel Pump is designed to make this process slightly less annoying. It has a small handheld part that holds a needle that you can use to pick up tiny components with a vacuum. You place the component, then a foot pedal releases the vacuum, and you can move onto the next

component. This isn't a new idea, and vacuum pumps have been around for about as long as surface mount components.

The things that make Pixel Pump stand out are its hackability – the firmware is in MicroPython, and there are two unused ports that you can use to add whatever additional hardware you want.

Additionally, there are optional racks for dispensing components.

Much of what will (or won't) make Pixel Pump stand out as a great device is how it actually feels in use. Devices like this are very much dependent on things that

are very hard to tell without actually holding it in your hand and using it. From what we've seen, Robin Reiter (the creator), has put a lot of time into making sure it does feel great, but since we've not had a chance to use it yet, we can't say for sure. □

// Much of what will (or won't) make Pixel Pump stand out as a great device is how it actually feels in use

//



BUYER BEWARE

When backing a crowdfunding campaign, you are not purchasing a finished product, but supporting a project working on something new. There is a very real chance that the product will never ship and you'll lose your money. It's a great way to support projects you like and get some cheap hardware in the process, but if you use it purely as a chance to snag cheap stuff, you may find that you get burned.



Left  What is this? A vacuum cleaner for ants?



NEW PRODUCTS

START HERE

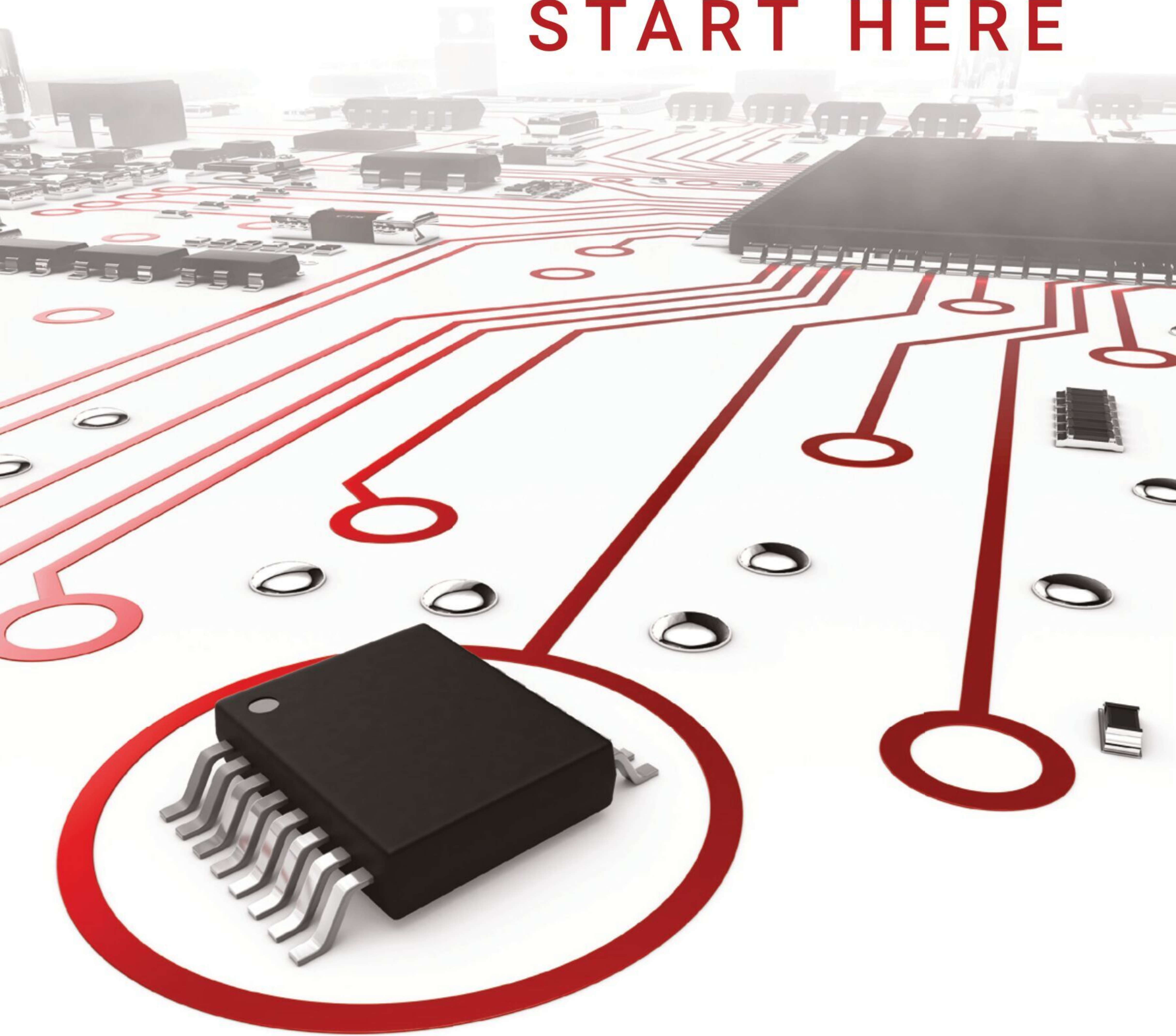

Looking for the latest products? Look no further. With over 400,000 new products stocked, we've got your electronic component and automation needs covered.

Find it at [digikey.co.uk/new](https://www.digikey.co.uk/new) or call 0800 587 0991.



Digi-Key is a franchised distributor for all supplier partners. New products added daily. Digi-Key and Digi-Key Electronics are registered trademarks of Digi-Key Electronics in the U.S. and other countries. © 2022 Digi-Key Electronics, 701 Brooks Ave. South, Thief River Falls, MN 56701, USA

 **ECIA MEMBER**
Supporting The Authorized Channel

LENS

HACK | MAKE | BUILD | CREATE

Uncover the technology that's powering the future

PG
38



HOW I MADE: WATER BUTT PLUS

Motorise and monitor water flow – just in time for this year's drought!

PG
44

INTERVIEW: ELLIE WEINSTEIN

3D printing in chocolate – just as much fun as printing in PLA, but a lot tastier



PG
52

IMPROVISER'S TOOLBOX: POLYSTYRENE

Insulate, carve, melt, and more with waste packaging material

PG
58

IN THE WORKSHOP

Simple tool modifications to make sawdust more accurately

PG
26

Food Hacks

Toast, grill, and bake better with these ingenious culinary builds

Arduino

Stepper motors

Lasers

LEDs

Food & Drink

When the worlds of gastronomy and making collide, the results can be delicious. Phil King has put together a tantalising tasting menu



Ingredients include

T

he realms of making and amateur cookery have much in common.

Chefs/makers mix up ingredients/components at home to concoct a creation that they hope others will admire and enjoy. So, combining the two hobbies is surely a recipe for success?

In this feature, we'll be sampling a wide range of culinary-related projects, so there's sure to be something to pique anyone's appetite to remake one, adapt an idea, or be inspired to create a unique invention of their own.

While many of the projects are based on electronic ingredients such as single-board computers and microcontrollers, they vary greatly in maker skill level. So don't worry if you're a novice in the kitchen/workshop.

For our hors d'œuvre, we present some handy cookery gadgets, including a robotic sous-chef that uses machine learning AI to identify ingredients in a pan. For the lazy eater, there are machines to automate the process of making tacos and grilled cheese sandwiches.

Next comes an entrée in the form of baking aids such as a chamber to keep your sourdough starter at a constant temperature, a slickly engineered pizza oven, and a machine for making cupcakes.

To cleanse your palate, we deliver an appetiser in the form of beverage-related items such as a smart bartender, home brewing system, and voice-controlled coffee machine.

Finally, for dessert, we have some ideas for growing your own food with the aid of a variety of smart gardens and a mushroom cultivation system.

Admittedly, we've merely dipped a finger into the vast bowl of food- and drink-related projects that have been created by makers the world over, but we hope that you will be inspired to unleash your inner chef-cum-inventor and start creating 'dishes' with your own personal flavour. →

Raspberry Pi

Arduino

LEDs

Relays

Lasers

Stepper motors

Kitchen Gadgets

Whether you need a little extra help in the kitchen or just want to be entertained, these DIY devices will come to your aid



hsmag.cc/TedToaster

Ted the Talking Toaster

Of course, what you really need in the kitchen is an appliance with personality. Created by Dane and Nicole of the 8 Bits and a Byte YouTube channel, Ted is a toaster with an attitude. With a Raspberry Pi 3 Model B brain assisted by a Google AIY Voice Kit and the Dialogflow chatbot API, he can listen and talk back to you. The addition of a pair of eyebrows moved by mini servos enables Ted to convey a range of emotions, including angry, sad, and frisky!



OnionBot Robot Sous-Chef

Sometimes when you're busy in the kitchen, preparing various ingredients while managing cooking timings, you may feel like you need an extra pair of hands. Maybe a robotic sous-chef could help? That's just what design engineer Ben Cobley thought when he cooked up the OnionBot project for his master's thesis at Imperial College London.

Powered by a Raspberry Pi 4, this smart countertop hob tackles the task of automatic pan cooking using AI derived from machine learning. A wide-angle camera and thermal sensor array above the hob enable OnionBot to identify what's in the pan and sense its temperature. A servo is used to adjust the heat level of the hob accordingly, while a 7-inch touchscreen shows recipe instructions and reminders for the human chef to stir the pan when needed. Find full instructions, 3D print designs, and code at github.com/onionbot.

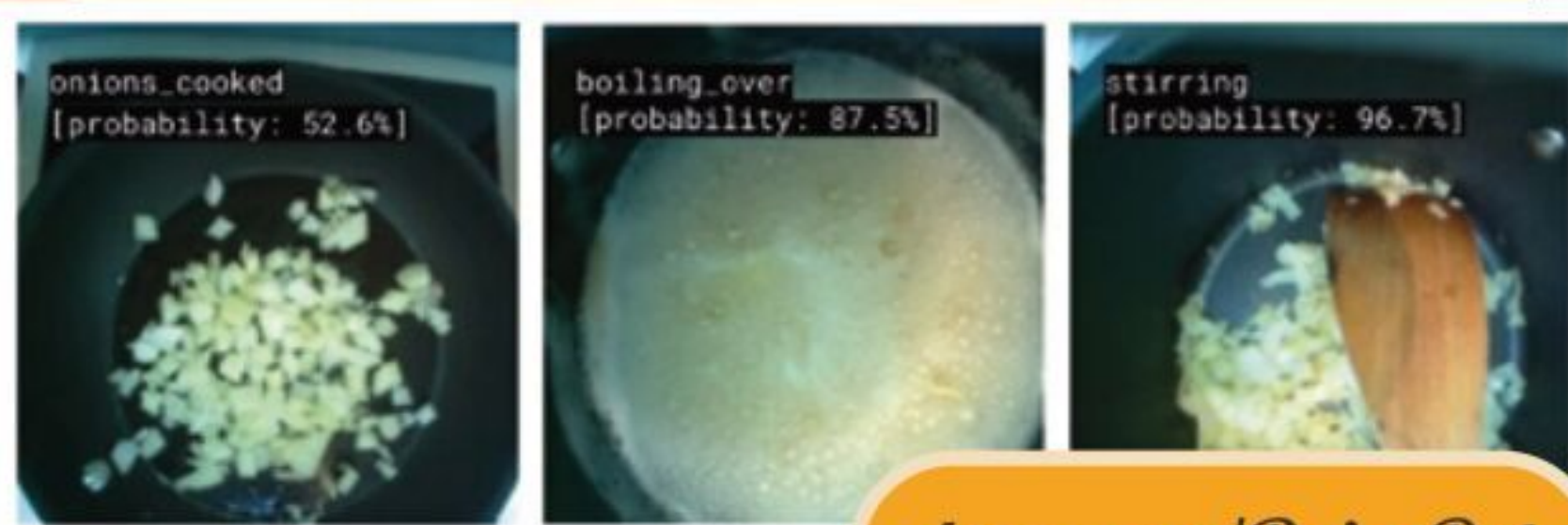

hsmag.cc/OnionBot

Tacobot

If you love Mexican food, the idea of a voice-controlled taco-making robot will surely tickle your taste-buds. OK, so Vije Miller's Tacobot doesn't work perfectly, but it's a fun proof of concept whose ingredients include an Arduino Uno, servos, stepper motors, liquid pumps, and scavenged 3D printer parts.

First, a robotic arm picks up a tortilla and drops it onto a special plate whose halves fold up at an angle to form a taco shell. It's then moved along a conveyor until it's underneath a rotating dispenser with compartments for ingredients such as ground beef, onions, cheese, and tomatoes that are dropped into the taco shell.

The wetter ingredients tend to stick together and so only dribs and drabs of them drop into the shell. We're not sure we'd want to eat a cold taco either. Still, when it's perfected, it's going to be brilliant.



hsmag.cc/Tacobot

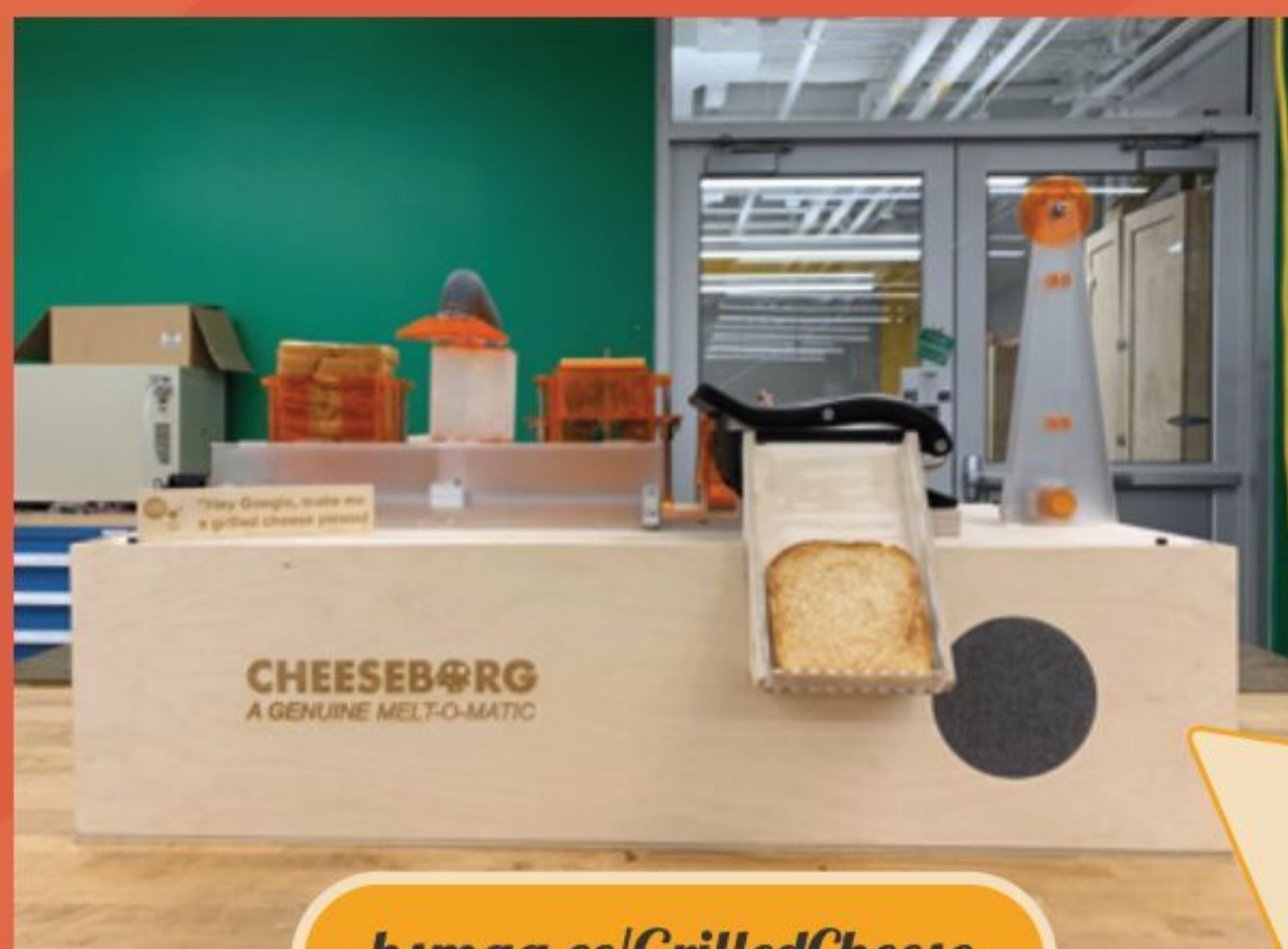

hsmag.cc/GrilledCheese

Cheeseborg Grilled Cheese Maker

A grilled cheese (aka cheese toastie) is one of the great comfort foods. So what better than a machine to make one for you? Taylor Tabb and a couple of friends cooked up Cheeseborg for a mechanical engineering degree final-year project. "As hungry college students awake at hours that it's often hard to find food, we knew this was our calling – not just for us, but for grilled cheese eaters everywhere," he says.

With the use of a Raspberry Pi and AIY Voice Kit running Google Assistant, you can simply ask Cheeseborg to make you a grilled cheese and it'll start making one. An Arduino Mega handles all the mechanical parts, including stepper motors and linear motion carriages. A vacuum tube picks up slices of bread and cheese from stacks; the grill plates are then sprayed with butter just before cooking, for a lovely crispy sandwich, which is pushed down a chute ready for you to eat.



Laser Microwave

You might think that microwaves blasting your food are pretty powerful, but YouTuber and microwave enthusiast Styropyro noticed that such ovens only operate on a half-wave basis. So, by upgrading his oven magnetron's half-wave voltage doubler to a full-wave circuit, it would "double the power and then some!"

With the addition of a bank of high-power blue laser diode arrays, he ended up turning it into a fully-fledged laser oven. "The new oven draws about 2kW of power, and about 700W of that makes it out as laser light," he reveals. He's cooked a variety of foods with it, including marshmallows, popcorn, hot dogs, and toast, with mixed results.

Note that microwaves and lasers are both very dangerous, so you should only experiment with them if you really know what you're doing – and make sure you have proper shielding, including laser goggles. →

hsmag.cc/LaserMicrowave

Baking Hot

Whether for making bread, cakes, or other baked foods, these projects are more than just hot air

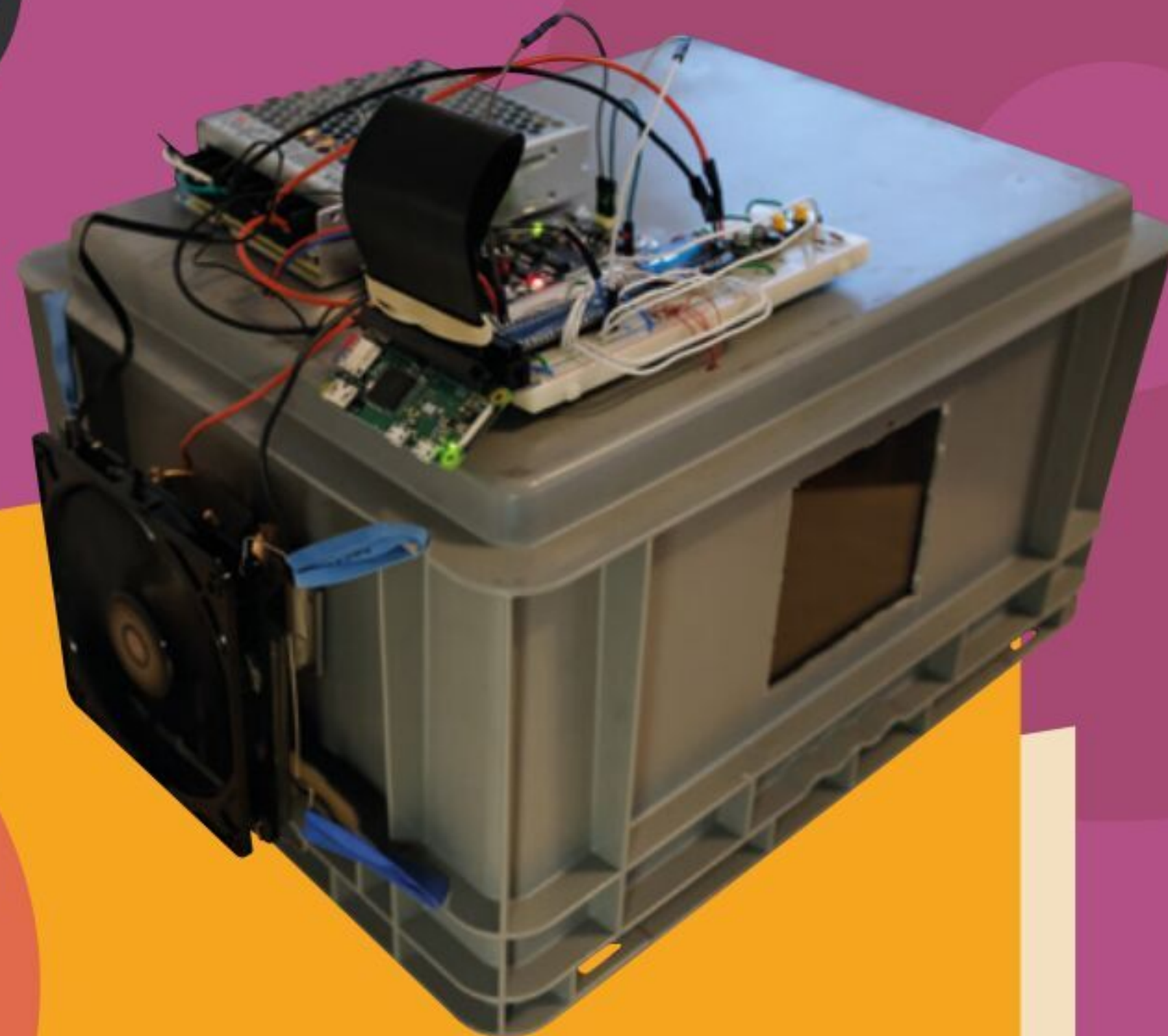

Sourdough Chamber

When maker, and keen baker, Trent Fehl first started making sourdough bread, he realised that keeping the starter at the correct, steady temperature wasn't so easy. He also found there was no commercial kitchen countertop device that can maintain temperatures above and below room temperature. So, using his loaf, he built his own.

By reversing the voltage on a Peltier cooler (a solid-state heat transfer device), controlled by a Raspberry Pi Zero and H-bridge, his Chamber can either pump heat from inside to the outside to cool the interior, or vice versa to heat it. This enables it to maintain a set temperature over long periods of time – perfect for sourdough starters and also pickling, mushrooms, and yogurt.

hsmag.cc/SourdoughChamber

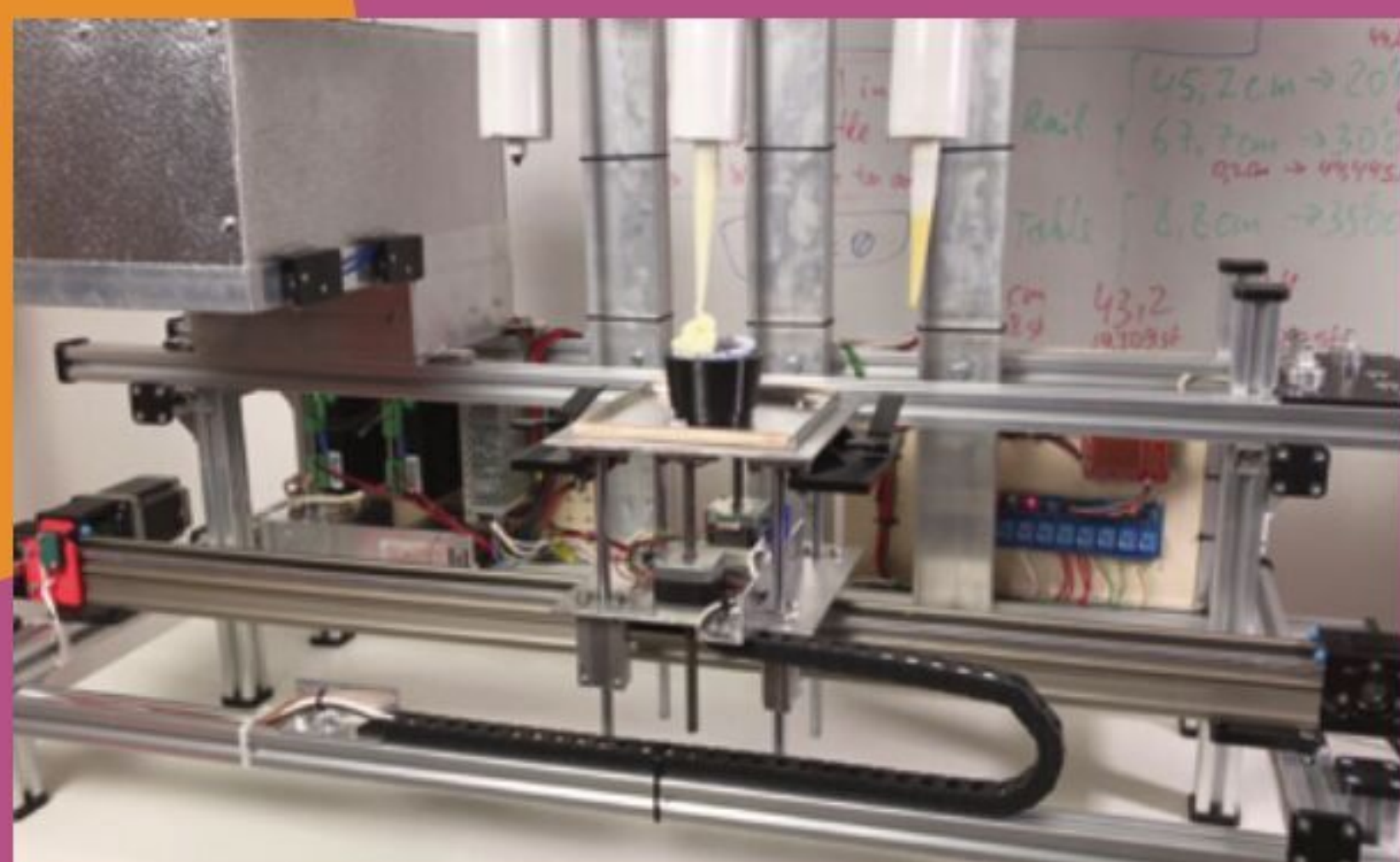

Cupcake Machine

If you have a sweet tooth, this cupcake-making robot is like a silver dream machine. Like a cupcake railway, this Arduino-based contraption moves each cake along rails from a dough station to a cooking station (an adapted mini microwave oven) and on to a topping station.

One stepper motor moves it along while another lifts its platform up and down for each station. Eight relays are used to control everything, including the microwave. Silicone guns are used for dispensing the dough and two toppings. After a lot of experimentation, maker Skyentific eventually managed to get it all working and made a decent cupcake. One issue was microwave leakage, requiring springy metal strips for a better seal as the platform rises into the oven.

hsmag.cc/CupcakeMachine



Light-Up Cake

Master bakers can create some absolutely amazing cakes, but to go one better, how about one that lights up? That's what Alicia Gibb (aka Betty Hacker) did for her own wedding cake. The safely encased electronics block was secreted in the middle, with a battery pack wired to tiny LilyTwinkle boards and LEDs that look like flowers on the outside of the cake.

She has also used electronics in cakes for friends and family. These include a Game Boy cake with two arcade buttons to play sounds, and a birthday cake with LEDs instead of candles. Alicia recommends small Tupperware boxes for housing electronics, and offers an important piece of advice: "Bake the cake first, according to your recipe. Do not bake the electronics directly into the cake."

bettyhacker.com

Tandoor

Back in HackSpace issue 10, editor Ben showed how to build your own tandoor, a roughly cylindrical clay cooking oven heated by wood or charcoal. This ancient cooking method is used all over the Indian subcontinent, and imparts a unique flavour with its combination of heat and steam. Typical foods include kebabs and naan bread.

As Ben revealed, you can easily make your own outdoor tandoor oven with the use of a Dremel tool and a few terra-cotta plant pots. The key to successful cookery is to get it hot enough – around 400°C – without overdoing it and risking the pots cracking. For the full build guide and other details, download the free PDF of issue 10 from the link below.



hsmag.cc/issue10

Portable Pizza Oven

Proper pizza ovens can maintain temperatures much higher than your average kitchen appliance, perfect for cooking up authentic Neapolitan-style pizzas with a light, airy crust and crispy bottom. You don't need to build a wood-fired brick oven or spend big money on a commercial offering, though.

Maker Andrew W has built his own portable pizza oven (the third iteration) from sheet metal rolled into curves and welded to form the basic shape. To provide the heat, he added two homemade gas burners – one at the rear of the oven, equipped with a flame diffuser, and another underneath a cordierite stone slab for base heat. This enables the oven to reach temperatures of up to 480°C (900°F), hotter than any commercially available portable pizza oven. As well as pizza, it's great for cooking naan bread. →

hsmag.cc/PortablePizza



Drinks on the House

Whatever kind of beverage you prefer, there will be a project to enable it to be made or enjoyed more easily

Smart Bartender

If you enjoy sipping a cocktail but don't want the hassle of making them, a robotic bartender is an option. It's a popular project in the maker world with many variations – we've even seen one housed in a grandfather clock – but Hacker Shack's Smart Bartender is one of the slickest.

With a Raspberry Pi 3 as a brain, it's pretty smart too. Able to mix up to six ingredients together at the same time, it can serve you anything from a rum and coke to a Long Island iced tea. You can easily change the ingredients by placing the pump tubes at the rear into different bottles. You could also customise the device to add more ingredients to make a wider range of drinks, or even link it up to a voice assistant. Check out the full build details, including constructing a wooden frame, on Hackster and find the code on GitHub.



hsmag.cc/SmartBartender



Bevvy Boat

When you're relaxing in the pool on a hot day, it's a pain to have to get out of the water to go and fetch a drink or snacks. Step forward the remote-controlled Bevvy Boat! After discovering that the only commercially available drinks delivery boat had been discontinued, Alister of electrosync – maker of “obscurely, useful, things” – decided to build his own.

The hull was 3D-printed in four sections in a shocking pink colour scheme. Propulsion is provided by “cheap brushless thrusters” with a 4S LiPo battery powering two water-cooled 30A ESCs – so it's pretty fast across the water.

The boat has four compartments for drinks bottles, along with a central bowl for snacks. That's not all, though. For fun, a mini water cannon was added to squirt pool guests, with aiming aided by a first-person-view camera video feed for the boat captain. An MP3 player and speaker plays music or shouts commands, and there's even a tiny flag-pole with a servo to hoist the Jolly Roger!



hsmag.cc/BevvyBoat

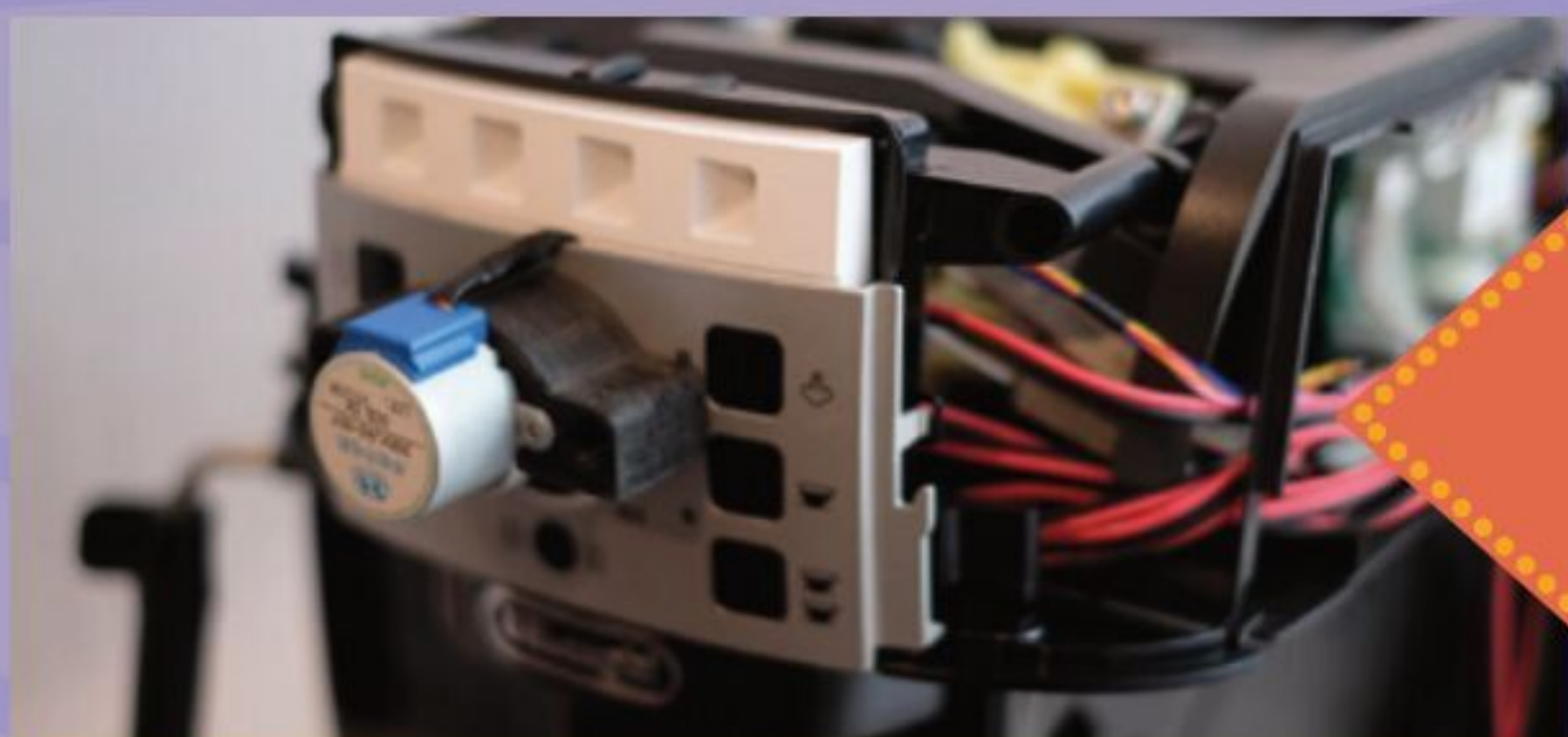

Voice-controlled Coffee Machine

hsmag.cc/VoiceCoffee

If you prefer your drinks hot and non-alcoholic, this voice-controlled coffee machine may well provide a caffeine hit. Just tell it what kind of brew you want, such as “two espressos”, and it'll do it for you automatically.

The team at **Snips.ai** (now part of Sonos) used their privacy-focused voice recognition software running on a Raspberry Pi 3 with a ReSpeaker HAT mic array to interpret spoken instructions. For the hardware, they modified an existing De'Longhi coffee machine, including the addition of an Arduino Nano to control a stepper motor to determine the intensity of the brew.

Full build instructions are given in the Medium article linked above if you want to try it at home. As always, take great care when modifying a mains-powered device.

Brew | LOGIC

People have been brewing beer for thousands of years, so why not have a go? We covered how to brew your own beer, cider, mead, and non-alcoholic drinks in our huge feature back in HackSpace issue 24 (hsmag.cc/issue24).

Brewing really good beer is an art, and numerous makers have created electronics projects to aid control of the process. Indeed, Ben Croston devised the popular RPi.GPIO Python library for controlling and reading Raspberry Pi's GPIO pins for his Fuzzy Duck Brewery back in 2012.

A more recent project – which may prove useful to home brewers – is Brew|LOGIC, a Bluetooth-enabled Arduino controller designed for single-vessel brewing, aka ‘brew in a bag’. Designed by LeapingLamb, it's akin to a sous vide cooker and maintains a steady temperature using sensors and a heating element. He's even created a custom Windows PC/phone app for remote control.

hsmag.cc/BrewLogic



hsmag.cc/Teasmade2

Teasmade 2.0

All this smart home stuff is nothing new. Back in 1932, WH Brenner Thornton invented the Goblin Teasmade, a special alarm clock that brewed you a cup of tea as soon as you woke up. The device had its heyday in the 1960s and 1970s, with models featuring faux art deco bodies and a built-in lamp.

Feeling nostalgic, Martin Spendiff and Vanessa Bradley modified a 1974 Goblin 854 Teasmade with a Raspberry Pi Zero and relay switch. Receiving its cue from a Google Calendar alert, the machine starts boiling the water ten minutes before the alarm. It even flashes patriotic red, white, and blue LEDs and plays *God Save the Queen* while it pours the boiling water for your drink. If you fancy making your own modified Teasmade, instructions and code are on GitHub. →



Grow Your Own

As growing your own fruit and veg is becoming ever more popular, there are projects to help manage that



Smart Indoor Herb Garden

With the advent of low-cost LED lighting, along with hydroponics, growing food indoors is now a serious business; there are even large subterranean farms producing lettuces and other crops. Advantages include a reduction in the required growing time, higher yields, and lower water use.

You can do much the same on a smaller scale at home by creating a smart garden, as lots of makers have done. One example is this smart indoor herb garden made by Sunyecz22. Based around an Arduino Mega, it features a waterproof RGB LED strip, TFT touchscreen, real-time clock, and four soil moisture sensors – one per planter pot. The smart-looking enclosure is made from 3D-printed parts, including an adjustable shaft for the LED lighting.

hsmag.cc/HerbGarden

Urban Kitchen Garden

If you've got an old wine cooler to hand, you could turn it into a smart food growing system like this countertop Arduino-based project. Made by Eric William, it's "designed to allow anyone, anywhere to have a modular, aesthetically pleasing, and simple device to grow food in their own kitchen."

To this end, while you could wire the components – including an LCD and relays – on a breadboard, there's the option of using Eric's open-source custom PCB design to connect everything more neatly. The Gerber files can be found in the GitHub repo (hsmag.cc/UrbanKitchenGH), along with a wiring diagram and the Arduino code. With sensors monitoring temperature, humidity, and soil moisture, the system can adjust the temperature accordingly using the unit's Peltier cooler.

hsmag.cc/UrbanKitchen

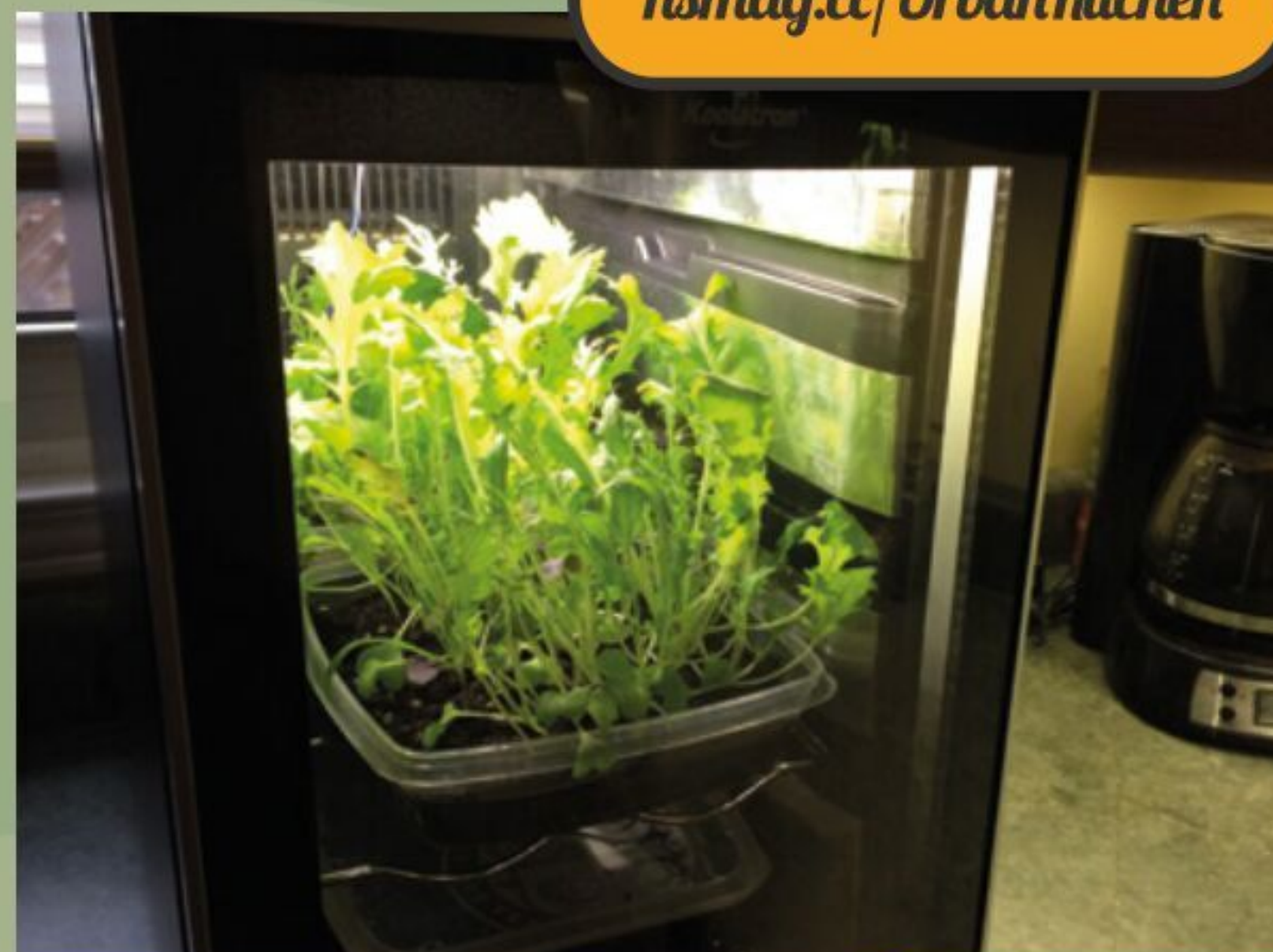

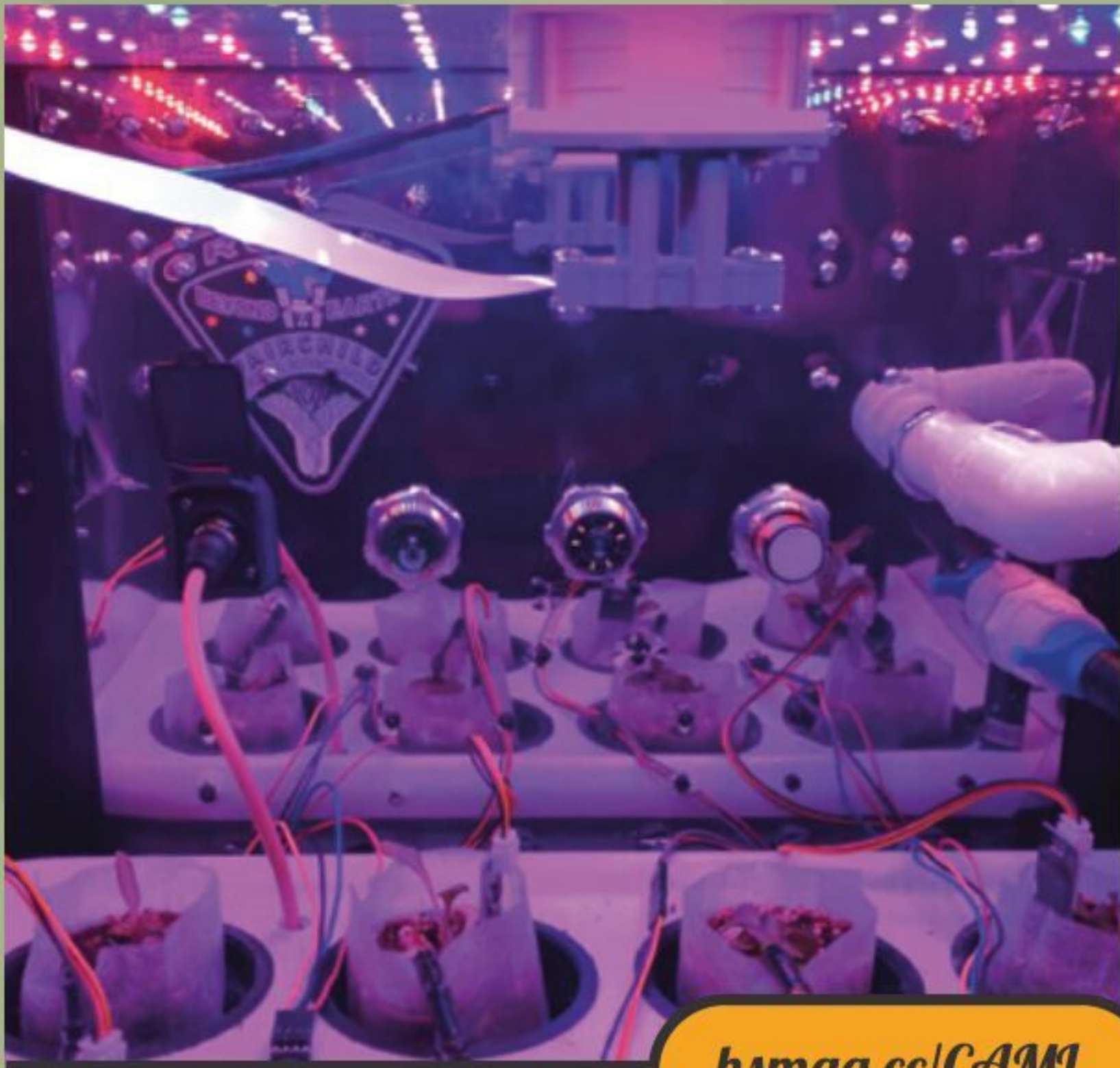

hsmag.cc/CAM1

CAM1

Designed with astronauts in mind, this 'food computer' is a fully automated plant growing chamber. Created by two eighth-grade students at West Hollow Middle School in Long Island, New York, it won the High School category in the NASA-sponsored 2020-21 Fairchild Growing Beyond Earth Maker Challenge. CAM1 is short for 'Computerized Agriculture Monitoring Interface', and it's packed with smart features.

Using detailed data collected by a network of sensors, it automatically controls an array of peristaltic pumps to add nutrients and make pH adjustments to the water supply. It also adjusts fan speeds based on air temperature and humidity, and switches between daylight and night-time visions to capture real-time and time-lapsed footage with a Raspberry Pi Camera Module NoIR.

All data is viewable in real time and historically via a touchscreen or Adafruit IO web dashboard, where the system's actuators may also be controlled manually.



Tomato Guard

hsmag.cc/TomatoGuard

Common pests such as snails and slugs are the bane of many a gardener. The little gastropods may be slow on the move, but they can quickly munch through the flowers, leaves, and young shoots of plants, along with their fruit, such as tomatoes.

Well-known solutions include beer traps and coffee grounds. Another one is copper tape, which they don't like moving over, but Matt of DIY Perks has gone one better by wiring up a 9V battery (protected from the elements by a makeshift case) to a copper tape circuit around his tomato plant container.

It's a low-tech solution, but really works: as demonstrated in his YouTube video, the snails are repelled by the electric current and won't traverse the copper tape. You could use a similar method to protect whole flower and vegetable beds in the garden. □



SUBSCRIBE TODAY

FOR JUST £10



Get three issues plus a
FREE Raspberry Pi Pico W
delivered to your door

..... hsmag.cc/FreePico

UK offer only. Not in the UK?
Save money and get your
issue delivered straight to your
door at hsmag.cc/subscribe.
See page 62 for details.

Subscription will continue quarterly unless cancelled

SUBSCRIBE on app stores

From £2.29



Buy now: hsmag.cc/subscribe

Free Pico with print subscription only



MAKE | BUILD | HACK | CREATE

HackSpace

MAKE | BUILD | HACK | CREATE
TECHNOLOGY IN YOUR HANDS | hsmag.cc | September 2022 | Issue #58

MAKE | BUILD | HACK | CREATE
TECHNOLOGY IN YOUR HANDS | hsmag.cc | July 2022 | Issue #56

SAVE 44%

HACK YOUR FOOD
Delicious builds to add fun and flavour to your cooking

Polystyrene
Build your projects with packaging

Protoboard
Custom-made holey PCBs

CHOCOLATE SCALPEL HINGES MUSIC

Robot Roundup
Make your Raspberry Pi move

Time-lapse Photography
Watch life on fast forward

LAZER CUTTING KNITTING

Maker's Market
Our IDEAS products that SELL

Alex GLOW
Build electronics without feeling like a jerk

RA SUBLIMATION FIREFLIES

HOW

By Andrew Lewis

I
MADE

***HACK THE
PLANET
AND TRACK
YOUR BUTT***

Keep track of your water usage
using a Raspberry Pi Pico

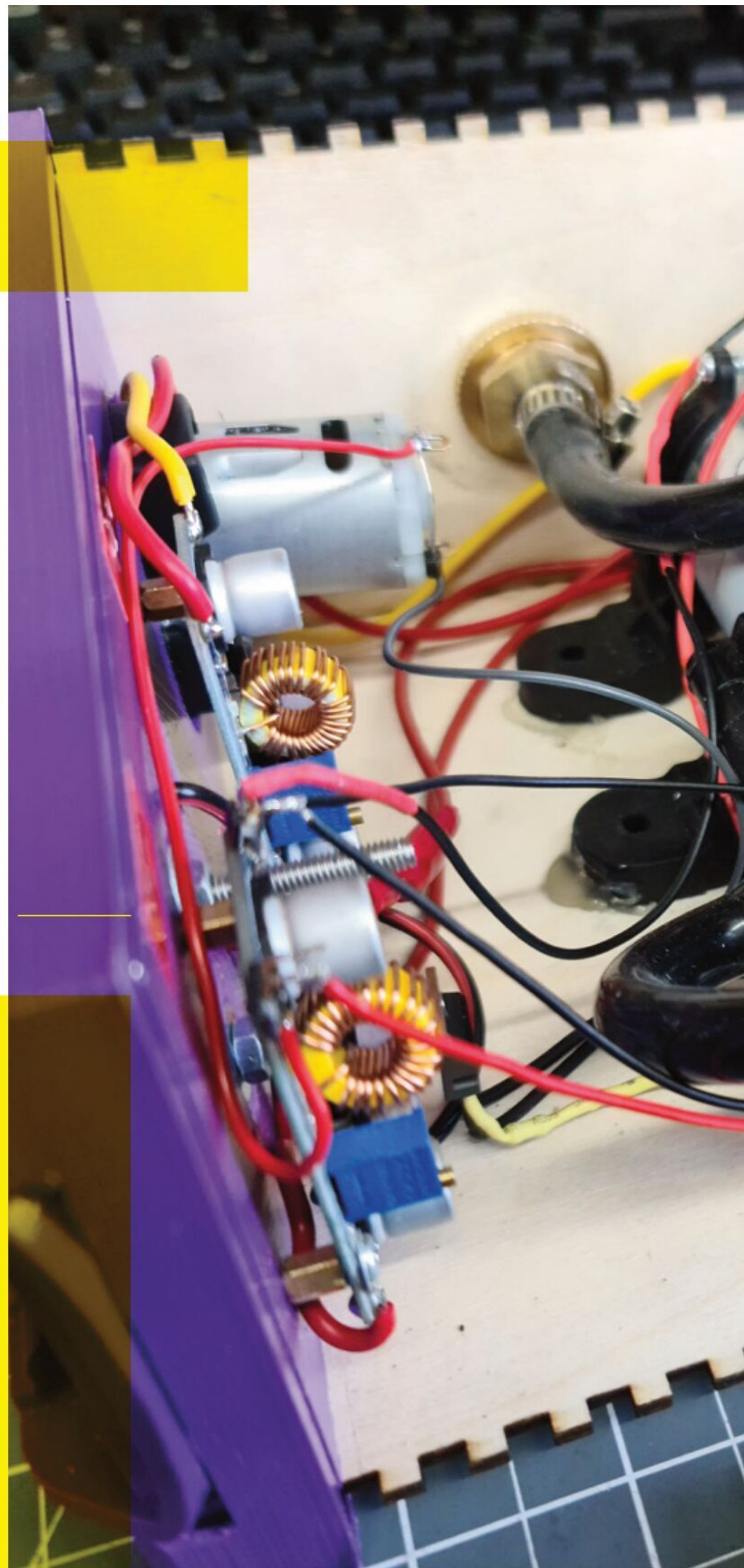

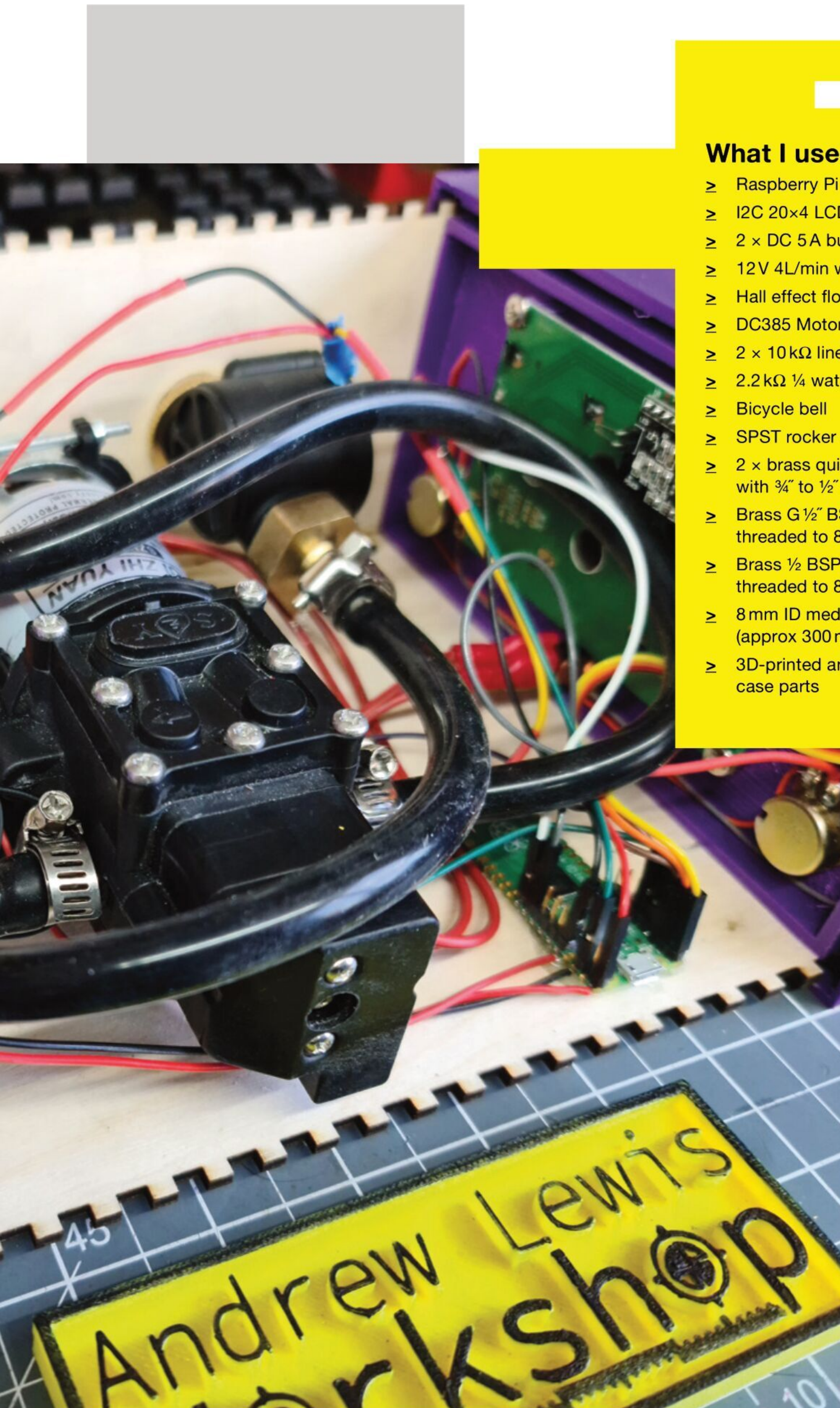

What I used

- ≥ Raspberry Pi Pico
- ≥ I2C 20x4 LCD display
- ≥ 2 × DC 5A buck converters
- ≥ 12V 4L/min water pump
- ≥ Hall effect flow sensor
- ≥ DC385 Motor
- ≥ 2 × 10 kΩ linear potentiometers
- ≥ 2.2 kΩ ¼ watt resistor
- ≥ Bicycle bell
- ≥ SPST rocker switch
- ≥ 2 × brass quick hose connector with ¾" to ½" adapters
- ≥ Brass G ½" BSP externally threaded to 8 mm barb
- ≥ Brass ½ BSP internally threaded to 8 mm barb
- ≥ 8 mm ID medical tubing or hose (approx 300 mm)
- ≥ 3D-printed and laser-cut case parts

Right ✘
Pressurise stored rainwater so that you can use a hose to water your garden

Rainwater harvesting is nothing new, and water butts have been popular with gardeners for hundreds of years. If your house is on a water meter, watering from butts is an easy way to save money. The only disadvantage is that, unless you have a large tank that's elevated above ground level, you don't have very much water pressure and hose-pipes won't really work. You'll be left carrying a watering can back and forth to your vegetables. Carrying cans is great for keeping track of how much water you've used, but isn't always convenient or comfortable. This project solves the problem by pumping water from the butt into the hose at pressure, and uses a Raspberry Pi Pico, with a flow sensor, to keep track of how much water you're actually using.

RING THE BELLS

The main parts of this project are the water pump, an electric bell, and a Raspberry Pi Pico with a flow sensor and display. When the machine is turned on, the Pico monitors the flow sensor and rings the electric bell when a user-defined quantity of water



GO WITH THE FLOW

The flow sensor used in this project uses a magnet on a pinwheel and a Hall probe to generate voltage pulses as water flows past the pinwheel. Each revolution of the wheel generates a pulse. Most Hall effect flow sensors work between 5V and 24V, which could potentially cause problems when interfacing with the 3.3V Pico. The 5V signal from the sensor can be reduced to 3.3V using a potential divider, or a dedicated logic level shifter like the TXS0108E, although, in practice, many sensors will work perfectly well from a 3.3V voltage source and level shifting isn't necessary.

Precision is relative

In general, flow sensors are not very accurate because the speed of the pinwheel can be affected by turbulence, low flow speeds, air bubbles in the water, or even by vibration and orientation of the sensor. For the purposes of monitoring water in a garden hose, the accuracy of a standard flow sensor is entirely appropriate (+/- 2% for the listed sensor).

The number of pulses that the sensor sends per litre of water will vary for different sensors, but for the sensor used in this project, one litre of water is equal to 450 pulses. This number is reflected in the `pulsesPerLitre` variable in the code, and can be changed to suit different sensors. If you're familiar with programming the Pico, then monitoring the pulses coming from the sensor probably feels like a job for PIO. For the frequency that pulses will be sent in this project, it's perfectly acceptable to skip PIO and set up an interrupt in MicroPython to increment the pulse counters in the code.

has been pumped out. It rings the bell for a longer time if a larger quantity of water has been pumped out. The amounts of water that trigger the bell are set using two potentiometers on the front of the machine. The idea behind having two bells is that the short bell (the ding) will tell you when you've used the amount of water suitable for one bed, while the long bell (the dong) tells you when you've used the amount of water for the whole garden. While this version of the project doesn't stop the pump when you reach the higher threshold, it is a very simple matter to change the code and add a couple of components to the design if that's the preferred method of operation. The project can be powered from a number of different sources, with the input voltage

Above  If you don't have access to a laser cutter, you can cut the side pieces by hand, without adding finger joints. The 3D-printed ends have a shaped recess for an aluminium angle that can be used to keep the corners of the box looking neat



Left ←
The LCD module runs from 5V, but you don't need to worry about level shifting the data and clock lines to 3.3V. The I2C connection master provides the necessary pull-up resistors, so your signal will be pulled up to 3.3V, not 5V. Most LCD modules use the I2C address 0x27, but because this project only uses one item on the I2C bus, you don't need to worry about this and can rely on the command `i2c.scan()[0]` to find the address of the first detected item

“USE ANY BOX TO HOUSE THE INTERNALS”

being dropped down to 12V and 5V with buck converters to power the pump and other systems, like the 20x4 I2C LCD display.

Although this project comes with 3D printing and laser cutting templates, you could use any box to house the internals. You could even use a wall-mounted box near to your water butt and power it using a suitable adapter.

To get the code for the LCD working, you'll need to grab a couple of libraries (`lcd_api.py` and `pico_i2c_lcd.py`) from github.com/dhylands/python_lcd. Les Pounder's instructions, which you can find at hsmag.cc/I2CLCD, will give you all of the information that you need to get this working.

The project uses two 10kΩ potentiometers to set the trigger values for the short and long bell sounds. These potentiometers are connected between the 3.3V and ground lines of the Pico, with the

centres connected to the analogue inputs on pins 26 and 27 of the Pico. The maximum and minimum values of these potentiometers can be set in the

code using the variables `dingMin`, `dingMax`, `dongMin`, and `dongMax`. The identifiers 'ding' and 'dong' are used throughout the code to refer to the short bell sound and long bell sound respectively, so `dingMin` refers to the minimum value of the dial that controls the short bell sound. The interrupt code for the project is very simple, calling the `handleFlowPulse` function when it detects a rising edge on pin 3.

The `handleFlowPulse` function is as minimal as possible, just incrementing each of the three counters that keep track of how much water has flowed through the system. The first two counters (`dingCounter` and `dongCounter`) are monitored by the main loop of the application, which will trigger the short or long bell sound and reset the →

How I Made: Hack the planet and track your butt

FEATURE



Left ← You can see that the interior of the bell is mechanically very simple, and modifying the bell to work with an electric motor needs nothing more than a drill and a hot glue gun. This photo shows the original bell, and the modified bell next to each other. The total cost of making an electric bell this way is around £5, and the sound is more distinctive than an off-the-shelf buzzer

counters each time they are reached. The third counter (**totalCounter**) keeps track of how many litres have been pumped since the machine was switched on. The litre value of **totalCounter** is displayed at the top of the LCD display.

The aim of this project is to add the convenience of a hose-pipe to the ecological and financial benefits of a water butt. Bolting a pump to a water butt would be

DING DING

Ring a bell to keep count of how much liquid is moving through a pump isn't a new idea, and some of you out there might be old enough to remember that some mechanical petrol pumps used to do this. A bell is a little bit more friendly on the ear than a mechanical buzzer or piezo alarm, but it's not as easy to buy small electronics bells as it used to be. Thankfully, it isn't too difficult to make one using a cheap bicycle bell and an electric motor. Lots of low-cost bike bells use a similar mechanism, with a lever pushing a gear that spins an arm with metal washers on the end. Centrifugal force causes the metal washers to fly out to the end of the arms and strike against the bell. If you remove the metal bell from the top of the mechanism and push the lever to ring the bell, you'll see that the centrifugal force causes the washers to fly right off the end of the arms at high speed, and you'll spend a good ten minutes trying to figure out where they landed in your workshop. It's a very simple mechanism that is easy to modify with an electric motor. The lever normally engages with a secondary cog that multiplies up the speed transferred to the centre shaft. If you remove the lever and mount the secondary cog onto a motor, you can simply drill out the existing mounting for the secondary cog to accept the motor. All that's left, from a mechanical perspective, is to hot-glue the motor into place where the old mounting for the secondary cog used to be. Depending on the exact bell you have, it might be necessary to cut away some of the back of the plastic bell case to accommodate the motor, and reduce the length of the motor shaft to prevent it from interfering with the rotating arms.

You don't need to use a particularly powerful motor to ring the bell, and 5V should be plenty to set the bell ringing. A DC385 carbon brush motor is a good choice for this application. You'll be triggering the motor using a TIP120 (or similar) transistor, so you need to be mindful of backwash currents, and use a diode across the motor contacts to absorb any reverse voltages generated when the motor stops. If you want to control the pump itself using the Pico, you can use exactly the same technique described here.

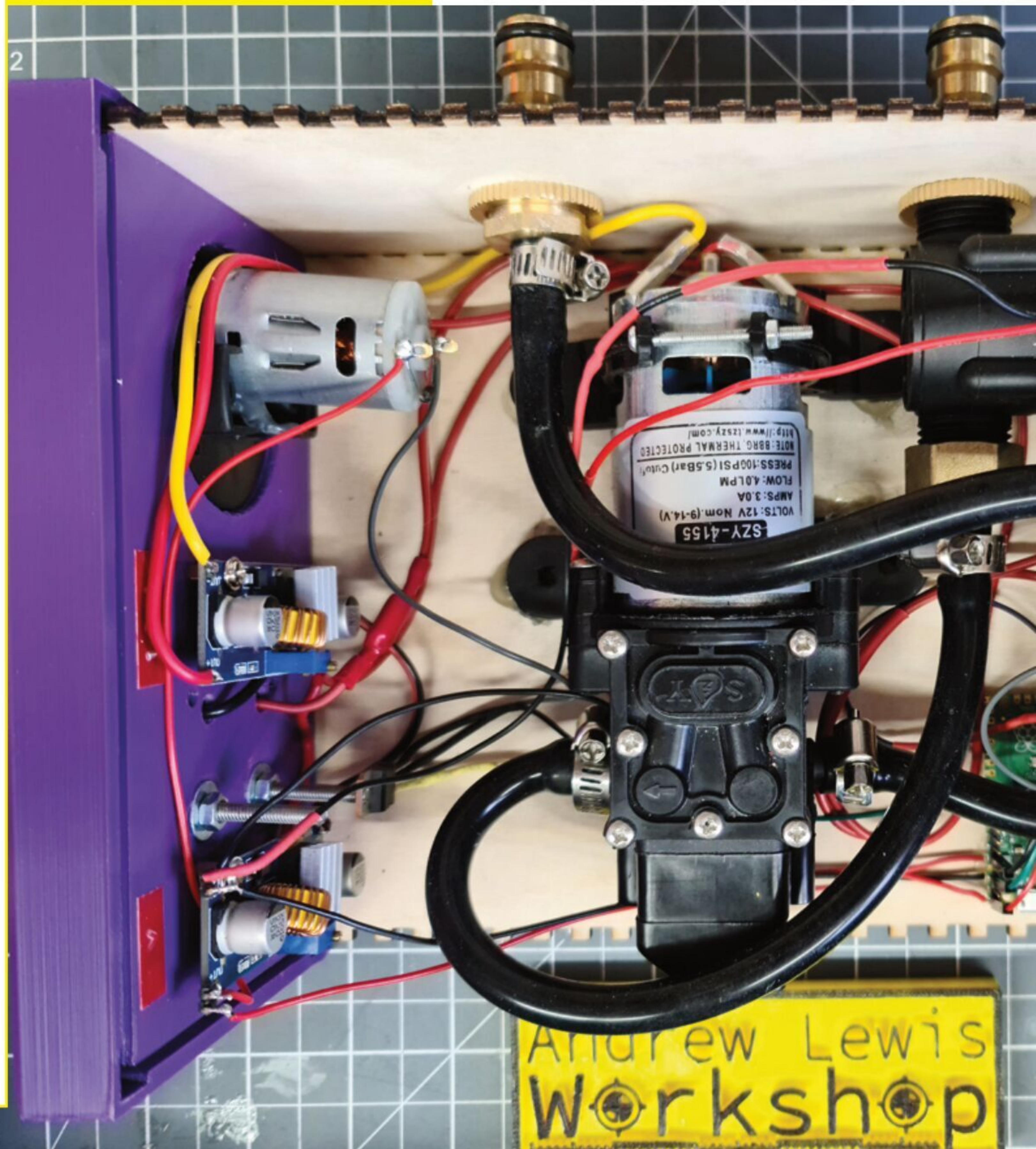

functional, but it would also make it hard to judge how much water was being used in comparison to watering with a can. Adding an audio cue as water is used, and a warning bell when the water usage is high, means that you can still get the functional benefits of a hose-pipe and also keep a check on how much water is being used. With a few simple changes, the project can be used to shut off the pump after a certain amount of water has been used, preventing accidental overwatering. With the added powers of a Pico W, you could even upload your water usage statistics to the internet. □

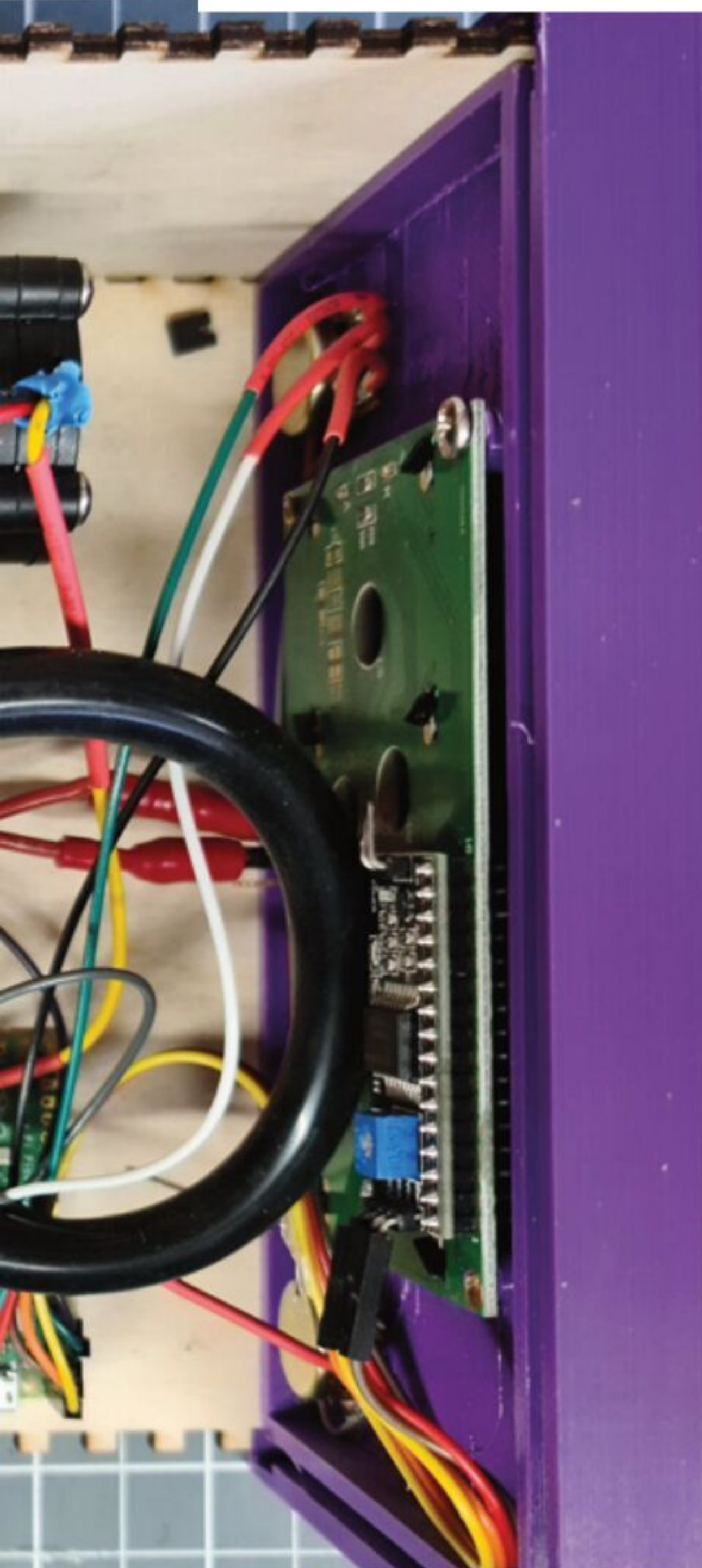

Left □ You can see that the water pump is positioned so that the inlet and outlet connectors are as far away from the panel-mounted quick connectors as possible. This extra distance helps to prevent kinks in the pipe that might restrict the flow

UNDER PRESSURE

The water pump used in this project has a built-in pressure switch. When the machine is turned on, the pump will immediately start pumping and will not stop until the pressure switch reaches its threshold pressure. The threshold pressure of the pump is 4–6 bar, which is in the same range as a domestic tap. That means when you connect a hose to the pump, it should behave like a normal tap. When you open the end of the hose, the pressure will drop and the pump will turn back on. The pump is designed to run at 12V, although it should be safe to vary the voltage by a couple of volts if you want to tune the performance of the pump and increase the flow. Remember, increasing the voltage will increase the heat generated, and too much of an increase might burn out the pump coils.

The water pump is connected to the inlet by a quick-release hose connector with an 8 mm barbed fitting. Fitting the connectors through the side panel of a project box can be accomplished by taking the 3/4" to 1/2" adapter that comes with the connector and using it as a nut to tighten the connector onto the panel. You will need to replace the seals with thicker versions to ensure a good seal, and use PTFE tape on the threads to prevent leaks. The outlet of the pump is connected to the inlet of the flow sensor, via a 1/2" internally threaded connector with an 8 mm barb. The outlet of the flow sensor is connected to another quick-release hose connector that is fitted through the side panel of the project box in the same way as the inlet, with the 1/2" externally threaded fitting of the sensor screwing into the internally threaded 3/4" to 1/2" adapter in the back of the quick-release connector. The pipes on all of the barbed connectors should be held in place with jubilee clips to prevent any leaks or slippage when the system is under pressure.

SAFETY INFO

This project uses electricity and water – two things that don't always get on well together. With the low voltages involved, the risk of a shock is minimal, but make sure that you understand the risks if you recreate this project. We strongly advise that you

DO NOT PUT A MAINS TRANSFORMER IN THE BOX AS A POWER SOURCE.

Below □ The pump operates directly from the battery. Unless you alter the wiring to trigger the pump from the Raspberry Pi Pico, the pump doesn't need to be shown at all in this schematic

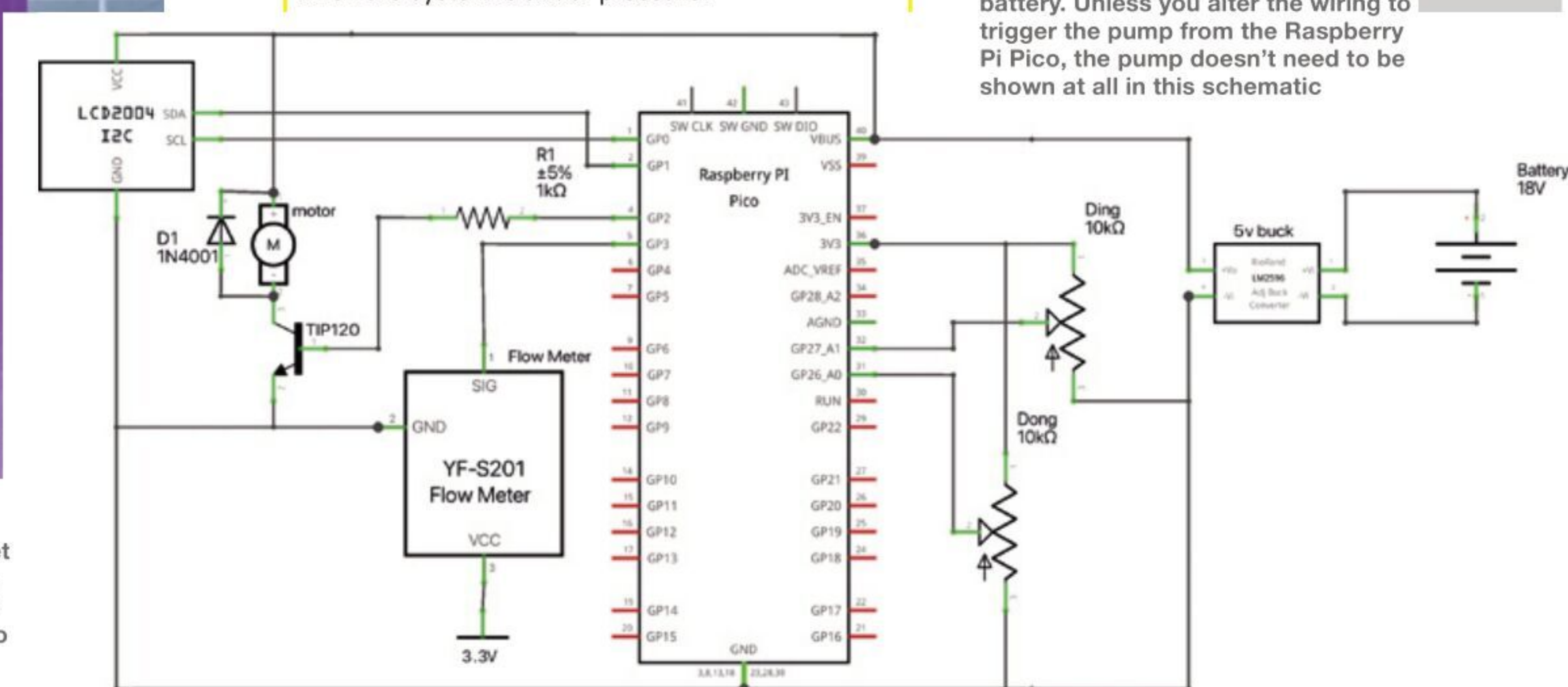

HackSpace magazine meets...

Ellie Weinstein

Chocolate – it's the new PLA

Eight years ago, a mechanical engineering student thought that 3D printing on chocolate would be easy... that was when Ellie Weinstein's journey into edible 3D

printing began. It turns out that it isn't easy at all – but that's led to a machine that's capable of reliably heating chocolate to within 0.1 of a degree, is food safe, and produces designs that just aren't possible with traditional methods.

We spoke to Ellie about her venture, Cocoa Press (cocoapress.com), the art of designing for chocolate, and what it takes to get a blend of sugar, fat, and cocoa solids to bend to your will. →



Below  Ellie Weinstein at the Midwest RepRap Festival, Goshen, Indiana

COCOA PRESS
A 3D PRINTER THAT PRINTS CHOCOLATE
 @cocoapress  @cocoapress
 facebook.com/CocoaPress
cocoapress.com

HackSpace So, before we get into the technical stuff: why 3D printing with chocolate?

Ellie Weinstein Yeah, so I guess there are a few reasons why 3D printing and chocolate go very well together. The first is obviously that it's delicious, and it's really fun to get to mess around with a whole bunch of different types of chocolate.

But the two reasons that actually make sense are customisation and being able to make things that are not possible with traditional chocolate-making. So, in terms of customisation, you can make one-off chocolate bars, you can do things that chocolate shops just wouldn't do, because they're not going to buy a custom mould for it. Or, you can just take your entire library of moulds (some bigger chocolate shops have a room full of moulds). Now that all fits on an SD card, so you don't have to keep all that physical stock out or buy each one individually. Similar to the original iPod, you have your whole album library on your hard drive now.

The second advantage is being able to make things that are not possible with traditional chocolate-making. And a lot of that comes down to really cool textures and infills. I literally just use the PrusaSlicer gyroid infill, as my favourite example of that, because gyroid tastes so good. It cracks in your mouth differently.

You can also do 3D designs with crazy overhangs that would be too delicate to make with the general flexible silicone-type chocolate mould.

HS That was going to be my next question: what does a 3D printer do that you can't do with a mould?

EW There's a lot of lead time for a custom mould. And custom moulds can be expensive: \$500 plus, if you're just making one or two of them, and the customer might not want to pay \$500. But if it can be, you know, \$1 of chocolate, and an hour of CAD time, that's way easier.

HS Does the printing process affect the taste?

EW Not at all, as long as you don't mess up the temperatures. If you mess up the temperature too badly, then you're going to cause that bloom issue.

HS Bloom. What's that?

EW Bloom is when the fat or sugar separates out. When the cocoa butter separates out from the cocoa solids, it'll get a white, powdery finish on the outside.

It also might not fully solidify. If you've ever had a chocolate bar that was left in your car or something, you might take it out, it might still be fine, but it's still a little bit bendy, or it's not quite as solid as it was before. Or, like if you snap it, it doesn't have that nice, crisp snapping sound – it's more of a bend and break. And that means the chocolate is now out of temper.

It's still perfectly safe to eat, but it just changes the texture, the mouthfeel, and sometimes the taste, if it's a more extreme bloom. But no, the printing process doesn't change it, as long as you're within normal parameters.

HS And how do you control those parameters? How do you make sure that the chocolate doesn't just melt as soon as it comes out onto the print bed?

EW Very precise temperature control is the answer. We have a multi-zone heating system. And we have an accuracy of a little high than about plus or minus 0.1 degree Celsius on the extruder.

Chocolate comes out of our machine at just below body temperature; that compares with around 200 degrees Celsius for PLA printing.

I don't know exactly how accurate the temperature of a Prusa extruder is, for example, but I guess it's to within at least two degrees. I do know that on Prusas, and anything running the Marlin 3D printing firmware, generally, temperature is stored as an integer, so you literally can't set it to any decimal point. That makes our temperature control at least ten times more accurate, in terms of what you can set it to. →



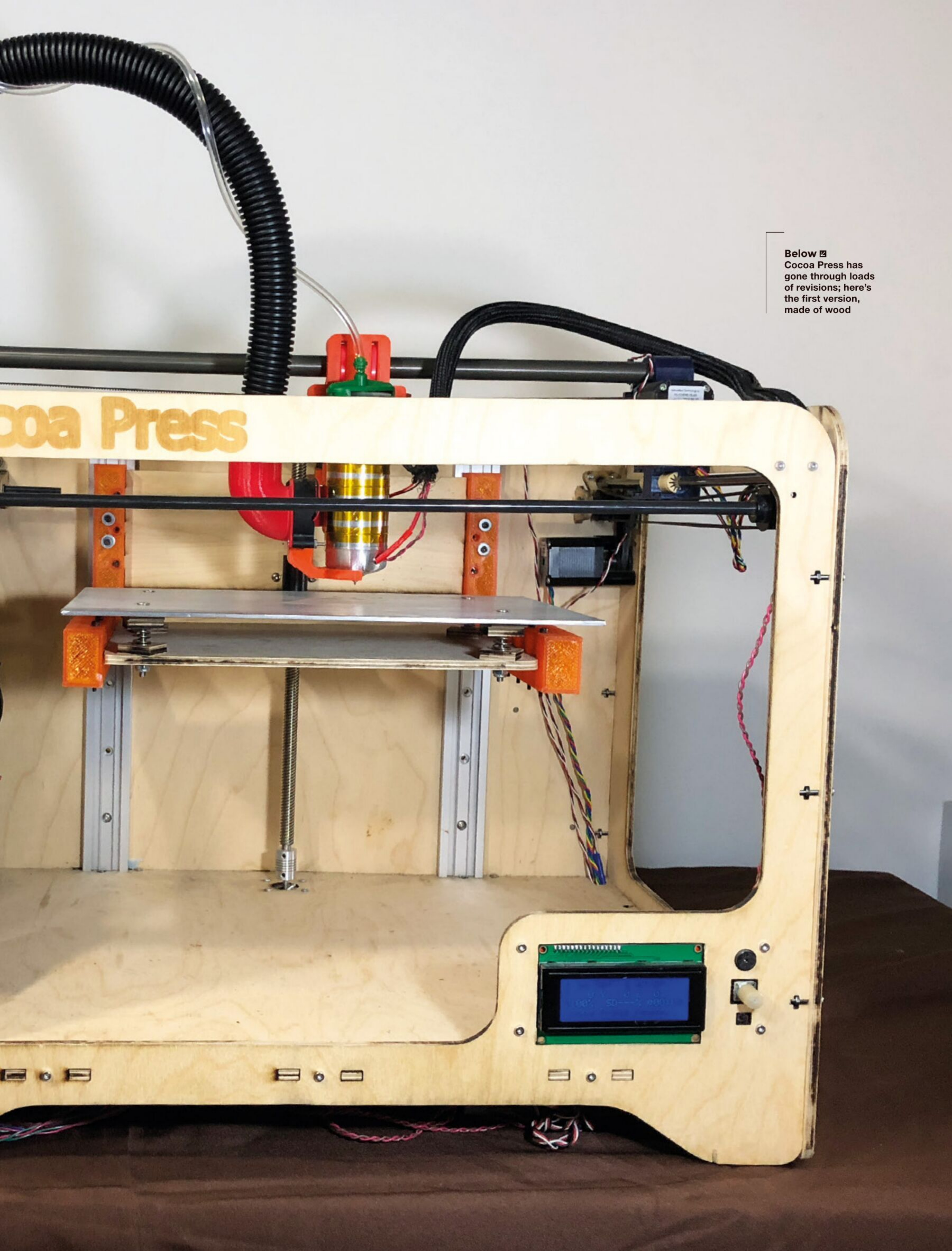

Below Cocoa Press has gone through loads of revisions; here's the first version, made of wood

HS Is that as a software control thing, or hardware? And is that what makes Cocoa Press Cocoa Press?

EW It's partially on the software side, partially on the custom electronics that we have. And then, partially, just on good mechanical design to retain heat in our extruder, and to control two separate zones: one right near the nozzle, and one that's the main body part.

HS This is a silly question, but I guess the chocolate isn't on a spool, like PLA?

EW It is not. I can never come up with a good analogy, but it's like a big cigar shape. And so, all of the chocolate for the print is heated up at once. And then we push on it with, I think, about 40 pounds of force.

We're heating it up to just below body temperature, the lowest temperature where it is somewhat liquid to extrude it, and then it's able to solidify immediately after extruding. Or at least within a few seconds.

HS What kind of chocolates do you use? Is there a specific blend that you've made for printing with?

EW This is where we're starting to change what we're doing. In the past, we've had our \$10,000 printer, that is fully enclosed, and had active cooling in it too. So, not only were we heating multiple zones, we were also cooling the build chamber. And, with that, you could use a wide array of chocolate: we used Belgian chocolate, I used to use Callebaut, then I moved to Guittard, because they're US-based and it was easier to get it. At one point I was using whatever I could get because, like everything else, chocolate has had supply shortages as well.

It's crazy. I've been calling up chocolate suppliers... minimum order quantities have gone way up, and sometimes chocolate is just sold out.

On our new version of the printer, it's just an early prototype that we showed

off at Midwest RepRap Festival [in June], we have our own special blend which solidifies at 80 degrees Fahrenheit [26.7 °C] which is, you know, warm for a room.

We're not going to lock anyone out of using whatever chocolate – if they have a cold room, they can stick the printer in the room. But the cost of this new printer is going to be approximately a fifth of the cost of the other one.

The main downside is not having that active cooling on board. But, with this new chocolate, it's going to work. It's just an early prototype, but the initial tests are incredible.

HS I'm not a big chocolate expert, but I do know that a lot of UK chocolate can't be labelled as chocolate in the EU because there's so little cocoa solid to it; I've tried some American chocolate and it tastes completely different again. How do different chocolate blends print?

The cost of this new printer is going to be a fifth, or something, of the cost of the other one

EW The sugar content doesn't seem to affect it that much; it's really the cocoa butter percentage or cocoa solid percentage. And palm kernel oil versus cocoa butter being the main fat in it. I also think it's just a shift in the larger chocolate industry; I've been doing this now for seven or eight years. And I did not come at this from a chocolate background, so I'm learning like everyone else. But I think there's a shift in the chocolate industry to use more palm kernel oil, as opposed to cocoa butter. And so, it's just been interesting material science, food science happening to keep the taste really good while switching the ingredients.

HS You mentioned infills a while ago. Does that influence how you design the chocolates?

EW I don't know if it influences how I design the files because I can just take any STL that I can print on a plastic printer and use it.

Overhangs are a little harder, as you might imagine. So I generally like to stay in the 30–40% infill range... with a 10% infill, sometimes the bridging is a little too far. And, you know, I can go higher on percentage infill, but I like prints to take less time and use less chocolate. Also, because we're limited by the amount of chocolate that's in a cartridge, I like to see if I can maximise the size of the object that I'm printing with one cartridge.

HS What sort of nozzle size do you have to use? I guess you can't go as fine as you would with hot plastic.

EW Yeah, so we use a point eight nozzle. I want to experiment with more at some point, but it's not the most important thing.

HS That's still smaller than I imagined.

EW Yeah, and I have some worries. We have played around very briefly with a point four and had some more clogging issues. I have worries that going bigger

will cause it to take longer to cool, and could actually give us worse results. It's just a theory – I've never tested it. But it's something I want to play with for sure. Because it could also let us go faster. Who knows?

HS What made you want to print in chocolate?

EW I kind of stumbled into it. It was a project in Intro to Engineering class [Ellie has a background in mechanical engineering]. And I was just, like, I wanted to build a 3D printer. And that project got denied because they said, 'Hey, look, we →

Below Dewsbury's own Jean Luc Picard, one of the first models printed on the current printer



C O C C O O A P P

LOVE



have a 3D printer right there – do something unique!

I was inspired partially by the PancakeBot printer to try printing food. And I thought chocolate would be easy to work with...so it's been about seven and a half years, and I'm still realising how difficult chocolate is to work with.

But the other side of it is that I started bringing it to events, New York Maker Faire, Philly Maker-Meetup, etc. And people were asking how to buy it. And so I started having more serious conversations, and realised that there might actually be a market for it.

HS What is the market for it? Is it 3D printing people? Or, is it to chocolate people?

EW So far, chocolate shops are mainly who I'm talking to. With this new printer,

there anything else that you've had to take into consideration?

EW I'm extremely happy with the general food safety of the whole system. The chocolate only touches four things in total: the cartridge body; the nozzle, which unscrews so it's easy to clean; there's one plunger piece on the top that acts as a seal, and then we have our silicone baking mat on the bottom, which is our print surface. All of those can be removed without any screws, and washed in the sink or whatever. So, it makes it extremely easy to clean and keeps the whole thing food-safe.

HS That sounds like very much a mechanical engineer's system.

EW Definitely, definitely. But that's my background.

"

We've been selling the chocolate, and now we're getting back to selling the printers

"

we'll see. That will be pitched a little more towards makers, but our high-end one is still towards chocolate shops.

The difference is mainly: are you trying to teach the chocolate side, or are you trying to teach the 3D printing side? Because, most chocolate shops don't have any experience with 3D printing. And I find the chocolate side easier to teach because I had to learn the chocolate side myself, and I just think we have a good system that makes the chocolate side way easier – you don't have to temper it yourself, it comes in pre-tempered cartridges etc.

So, we'll see whether this new machine reaches new customers, but, in the past, it's been chocolate shops.

HS What else have I missed – temperature of the print bed, the nozzle, the pre-extrusion heating – all these are different from printing with plastic. Is

We have a printer set up in the other room here, which is a certified food establishment space, so we can legally sell prints out of it, or do our chocolate.

We still test in this room, but for our actual setups, and for all of our Christmas orders, we're doing them in the food-certified room. (And that certification is specifically for the room, not for the device itself.)

There are two of us full-time at the moment – it's gone up and down in the past. We've been selling the chocolate, and now we're getting back to selling the printers. And that's why I'm excited about this new version – it probably won't be out until late 2022, early 2023, but I'm excited about it, because we're gonna get back to selling the hardware. And I feel like it's not every day that we can cut the cost by, you know, 75% and keep a similar print quality. So I'm just really, really excited about this new version. ▣

Left ▣
Creating this shape in a mould would be incredibly tricky; with 3D printing, it's easy



POLYSTYRENE

Packaging accounts for a significant proportion of what goes into our rubbish collections. **Rosie Hattersley** suggests ways to keep it out of landfill



Rosie Hattersley

[@RosieHattersley](#)

Rosie Hattersley writes tech, craft, and life hacks and tweets [@RosieHattersley](#).

Polystyrene goes by various names, including **Styrofoam, Thermocol, and expanded polystyrene (EPS)**. Received wisdom has it that polystyrene can't be recycled, so almost all of it ends up being discarded. Polystyrene is a thermoplastic,

meaning it can be heated up, becomes liquid at between 210 and 249°C and then moulded into a different shape. But, as a stable material, it is nearly indestructible and will take decades to biodegrade. It's also highly flammable and gives off noxious gases. The polymer was discovered in 1839 by German apothecary Eduard Simon, who successfully distilled styrol, while the material's rights were bought and commercialised as Styrofoam by Dow Chemical engineer Otis Ray McIntire in 1941. As a polymer produced from petroleum-derived hydrocarbons, and

that's been used for food is likely to be contaminated), but if you live close to one of the companies listed on the Expanded Polystyrene website, they will: [hsmag.cc/EPSRecycle](https://www.hsmag.cc/EPSRecycle).

If you have a significant quantity, you may even be able to have it collected and recycled for free. Although commercial reuse is uncommon, Cheshire-based company Highwood uses significant quantities of post-consumer polystyrene to create synthetic wood: [hsmag.cc/Highwood](https://www.hsmag.cc/Highwood).

Nonetheless, the advice that avoiding polystyrene where possible, and that recycling it is costly and not easy, holds true for all its varieties. A TED talk by inventor Ashton Cofer ([hsmag.cc/PolystyreneRecycling](https://www.hsmag.cc/PolystyreneRecycling)) suggested as much as 200 million tonnes of it is discarded annually in the US. His big idea, to turn it into an activated carbon air filter, was enough to earn him and his FIRST Robotics teammates the inaugural Google Science Fair prize for innovation.

To find a purposeful way to reuse any leftover polystyrene you may have, consider its original purpose: for insulation and to protect, or contain other items. It's a poor conductor of heat, hence its use as a container for hot drinks, as well as to keep cold drinks cold. Use the same idea by crumbling up discarded polystyrene and packing it in among the picnic items in your cool box to provide extra insulation and extend the usefulness of any ice blocks you're carrying. It also follows that you could use it to boost the insulation of your shed, attic, or other rooms that lose a lot of heat.

"THE ADVICE THAT AVOIDING POLYSTYRENE WHERE POSSIBLE, AND THAT RECYCLING IT IS COSTLY AND NOT EASY, HOLDS TRUE FOR ALL ITS VARIETIES"

the often-cited mantra that single-use cups should be avoided at all costs since they're impossible to dispose of responsibly, it's little wonder that polystyrene has such a bad rap. In fact, this is largely a cost issue.

Look closely at a polystyrene product and you might see an EPS label. If so, it's recyclable. Your local council recycling service won't take it (since any

THEATRICAL PROPS

Wobbly scenery, suspiciously easy-to-shift boulders, incredible space-age outfits – polystyrene has been a stand-in for much heavier items for decades in the worlds of film and theatre. With its tolerance for being carved, painted, and knocked about, it's an obvious choice of material when called upon to conjure up a fancy dress or cosplay outfit. YouTube is your friend when it comes to design ideas too. Grant (aka The King of Random) shows how to accurately slice sections of polystyrene

using his Styro-Slicer 'hotwire' foam cutter: hsmag.cc/StyrofoamCutter. It's ideal for precision tasks such as his Mini Master Sword and homemade planes, for which he provides downloadable templates, and can even add bevelled edges. Having cut out, glued together, and sanded out imperfections on your sword, you just need to spray or paint it. As a bonus, Grant adds some extra details of how to cast a sword shaft from sand in a polystyrene former. For another great attire idea, take a look at how to make this fantastic helmet: hsmag.cc/StyrofoamHelmet. →

Project Maker
THE KING OF RANDOM

Project Link
hsmag.cc/StyrofoamProps

Below ♦
Turn packaging waste into a duelling pair of swords →



DIY GARDEN WATERFALL

Project Maker
DIY JOY

Project Link
[hsmag.cc/
StyrofoamWaterfall](http://hsmag.cc/StyrofoamWaterfall)

Sticking with the idea of one material standing in for another, this low-cost waterfall makes use of lots of unwanted polystyrene sheets and blocks, with paint used to disguise what it's really made from. DIY Joy saw a similar idea at a friend's house and was fooled, in any case. Start by marking out a wall of bricks with a craft knife and then etching out the blocks. Paint your walls a brick-ish shade and

leave to dry, before gluing together at right angles (or a design of your choosing). Carve out a bowl from another piece of polystyrene and paint to look like a stone well, including a hole for a pipe to pump water back up into the waterfall mechanism. Add corrugated plastic or aluminium sheeting to form a rustic tin roof that will also act as a chute to deliver the water. Now, place a water pump behind your fake wall, connect it up, and position your waterfall ready for use.



Right  Polystyrene makes very convincing brick

STYROFOAM AIR-CON UNIT

If you're hacked off with unforgiving heatwaves, take a look at Household Hacker's YouTube video showing how to turn a Styrofoam icebox into a very cheap air-con unit. Such boxes are typically used as the packaging for chilled cases of wine, beer, and fresh food. Online giveaway sites such as Freecycle, Freegle, or a local Facebook page where neighbours swap unwanted items, are a great source. Add a pair of £2 air vents, trace around their bases, and cut out spaces for them in the lid of the polystyrene box. Add an old bathroom or computer fan, again tracing around it and cutting a hole for it,



this time plumb in the middle of the cooler box lid. A craft knife is ideal for carving out these slots. It's advisable to trace slightly inside the area for the fan so that this component rests on top rather than falling through the space you've cut for it. Now carve out strips as vents along one side of the remaining space on the box lid. Connect up the fan to a power source to check it works. Place plastic bottles of water you've previously frozen inside the body of the cooler box, and switch on your DIY air-con unit for some sweet relief from the heat.

Project Maker
HOUSEHOLD HACKER

Project Link
hsmag.cc/StyrofoamAirCon

Left  Chill your room on a budget

DIY SUPERGLUE

Among Green Redeem's many reuse ideas is the suggestion to transform Styrofoam packaging nuggets, and small pieces of polystyrene, into a sticking solution, thanks to – rather than despite – the material's polymer basis. You'll need a solvent such as acetone or limonene oil – an essential oil found in the pith of citrus fruits, but also available in hardware stores. Put the solvent into a

glass container with the polystyrene pieces, and stir with a wooden spoon so that the material is fully coated. The packaging material will rapidly break down into a glue-like substance similar to superglue, and can then be used to stick various items to each other. Rubber gloves, a ventilated room, and keeping everything away from any source of heat or fire are obvious precautions. There are lots of examples online: hsmag.cc/DIY_SuperglueVideo.

Project Maker
GREEN REDEEM

Project Link
hsmag.cc/DIY_Superglue

CODE
THE
CLASSICS
VOLUME 1

CODE THE CLASSICS VOLUME 1



Brimble
Crookes
Gillett
Malone
Tracey
Upton²





CODE THE CLASSICS VOLUME 1

This stunning 224-page hardback book not only tells the stories of some of the seminal video games of the 1970s and 1980s, but shows you how to create your own games inspired by them using Python and Pygame Zero, following examples programmed by Raspberry Pi founder Eben Upton.



- *Get game design tips and tricks from the masters*
- *Explore the code listing and find out how they work*
- *Download and play game examples by Eben Upton*
- *Learn how to code your own games with Pygame Zero*

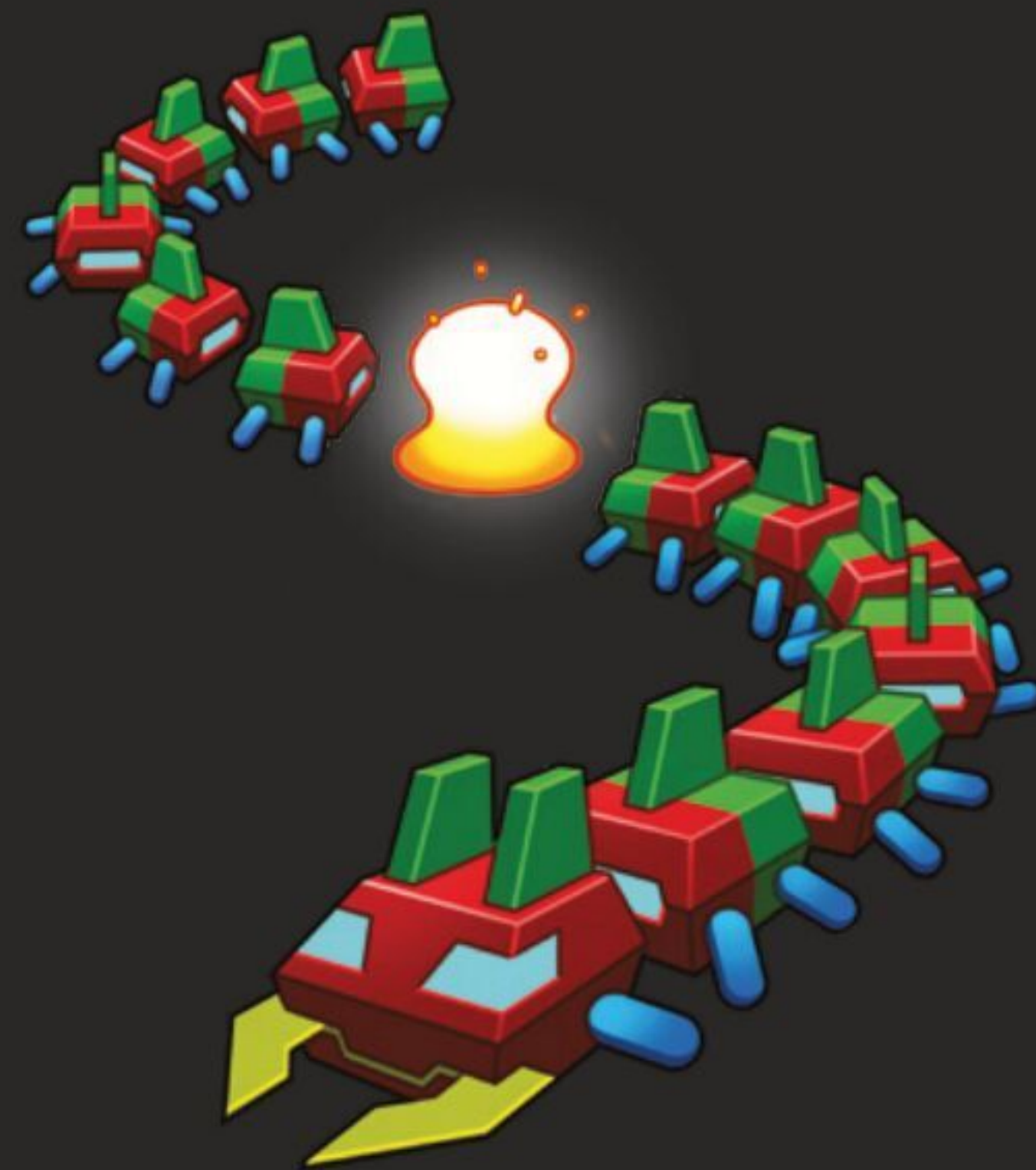

Available now hsmag.cc/store

In the workshop: Mitre saw upgrade

FEATURE

IN THE WORKSHOP: Mitre saw upgrade

By Andrew Gregory

Better cuts with a pair of quick fixes



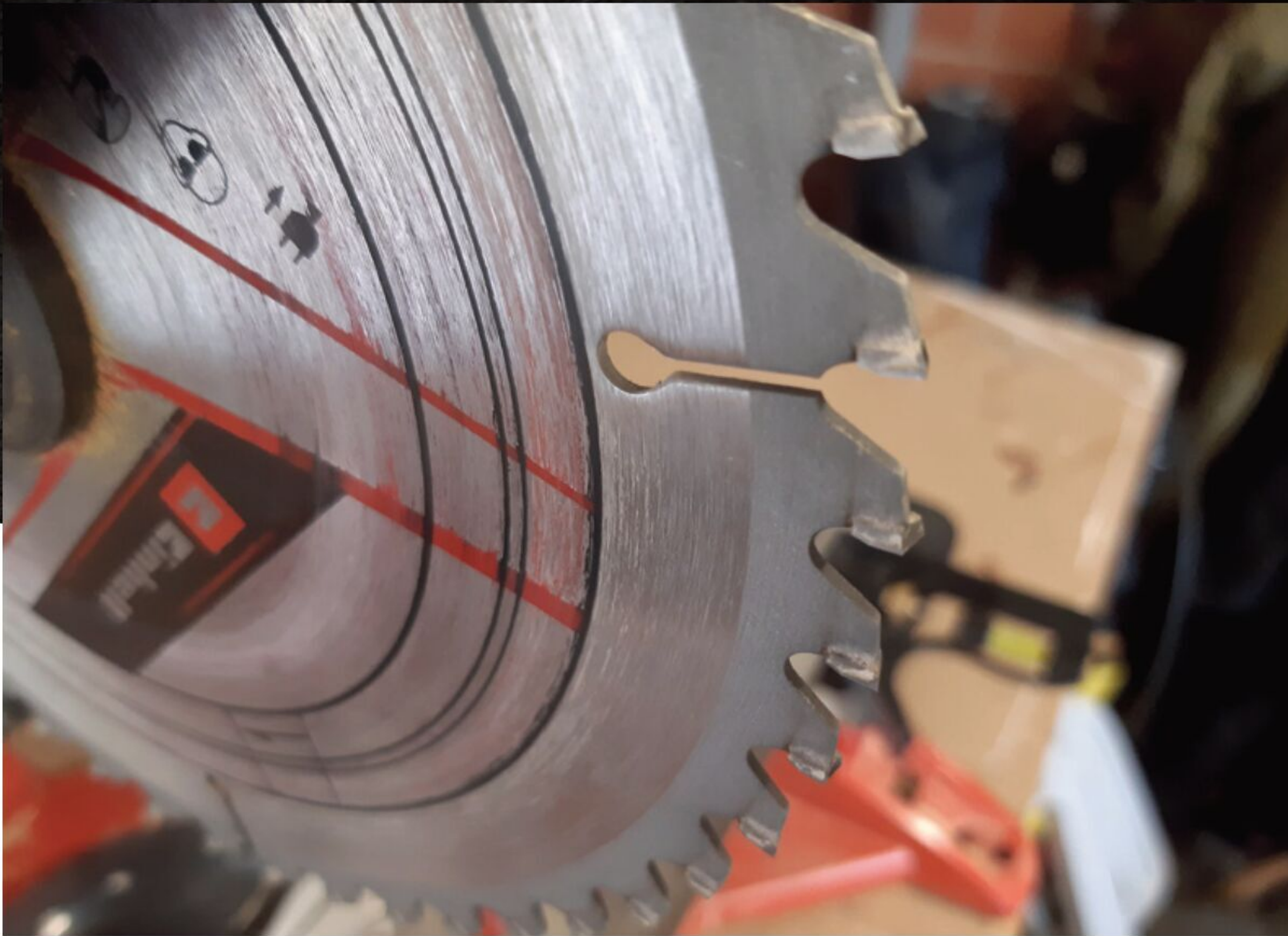

T

ear-out is annoying, but not inevitable. It's a consequence of the way wood is formed, and happens when, instead of cutting through the grain of wood, bits are splintered off at the end of a cut. There's a simple

way to avoid this, and that's to support the back of the workpiece so that it all stays where it should be, rather than getting obliterated by sharp bits of spinning carbide.

To show how this is going to work in practice, we measured the clearance gap in the base of our mitre saw and found it to be about 13mm. The kerf of the saw-blade measured 3mm, so there's 5mm unsupported on either side of the saw-blade as you cut. This is fine for rough work, but for anything decorative, such as furniture, tear-out can ruin the workpiece, so we're going to perform a couple of upgrades.

First, the zero clearance plate. As the name suggests, this will turn the current 5mm of clearance into 0mm of clearance, by supporting the wood being cut underneath.

We found on our machine that the clearance plate (the black plastic insert with measurements marked on it) was held down by seven screws, with the seventh concealed under the fence (the piece of metal that holds the workpiece perpendicular with the saw-blade). That's OK, as it's only held on by a couple of Allen bolts. →

The clearance plate was held down by seven screws

Above ■ Our saw-blade's teeth have a kerf of 3mm

Below ◆ Out of the box, this saw has a gap of 5mm on either side of the saw-blade



FEATURE



No sacrifice at all

Our mitre saw is a sliding compound mitre saw, which means that you can use it to make cuts at any angle you choose from 90 to 45 degrees, in two axes – see below for an image of what the fence we’ve added looks like after we made a cut at 15 degrees. Repeat this, and the fence we’ve just installed is going to get chewed up pretty quickly. That’s OK though; it’s called a sacrificial fence because damage to it is inevitable. After a few weeks/months/years of use, you’re meant to replace it with a new one. There’s no avoiding this – it’s a function of wood being softer than metal, and it’s the same as many self-made woodworking tools such as bench hooks and even the workbench itself.

Above ▾
The first cut will go through the clearance plate and create a perfectly sized hole

Below ▾
The fence is a consumable, so will need replacing



On some saws, this inlay is square, which would have made this part a lot easier – simply measure and cut. As our saw uses a contoured inlay, we’re going to have to draw around the existing plate on a sheet of plywood, then cut around the outline using a jig-saw. This was a little messy, ironically, because of the amount of tear-out produced by the jig-saw. It also wasn’t the most accurate process, and we had to file down the edges before it would fit back in the base of the saw. Yes, the edges to this aren’t brilliantly accurate, but the only thing that matters here is that the surface is flat and level, so we had to remember to countersink the screw holes so that the screw heads wouldn’t stand proud of the bed that the workpiece rests on.

That in itself should be a huge improvement, but there’s another glaring shortcoming of the stock-saw: the fence is only about 30 cm wide. This means that for longer workpieces, I find myself dangling the wood over the side of the saw bed with nothing to support it, and when I’m making repetitive cuts (say, table legs), I have to put one accurately cut leg on top of the next workpiece, make sure they’re even at the left-hand side, and then shuffle the two bits of wood up to the blade before I make the cut. That’s not ideal: there’s a lot of hoping that nothing slips, and a lot of room for inaccuracies to creep in.

There’s a way to fix this: the use of an end stop. That’s a small piece of wood that clamps to a long fence on the back of the saw, and it means that when you’re cutting multiple workpieces, you only have to measure once, and everything else you cut using the same end stop will automatically be the same length.

First, we have to have something to attach our end stop to. We had to identify a suitable piece of wood – this should be long enough to accurately hold the



The only thing that matters here is that the surface is flat

longest thing that we're likely to cut. Here is where we needed to be realistic. Our most recent woodworking job was to patch up the holes in the fence where the dog had chewed through it. This isn't fine woodworking by any means, and we really don't want to attach anything 6-foot-plus to a tool that has to live in the garage. A decent compromise is 1 m in length, with a similar length on the scrap side. First, I tried to attach a piece of spare floorboard, but at 125 mm this would have interfered with the operation of the saw. We did have some perfectly sized MDF to hand, but as MDF contains known carcinogens, we reconsidered the wisdom of cutting this up and turning it into dust.

To attach the planed, square-edge pine that we eventually chose, we first had to drill holes in the aluminium fence that we removed and put back on earlier. It always feels weird taking a drill to something we've paid good money for, but this is going to make our purchase far more useful, so we held our breath and did it.

Four holes in the fence later, we screwed in four 4 x 16 mm wood-screws, found a clamp to hold the end stop, and we were almost done; the final step was to make a test cut, and we're pleased to say that the setup works brilliantly. □

Above ♦ Just a few screws hold the clearance plate in place

Right ♦ Jig-saws are quick but can leave rough edges

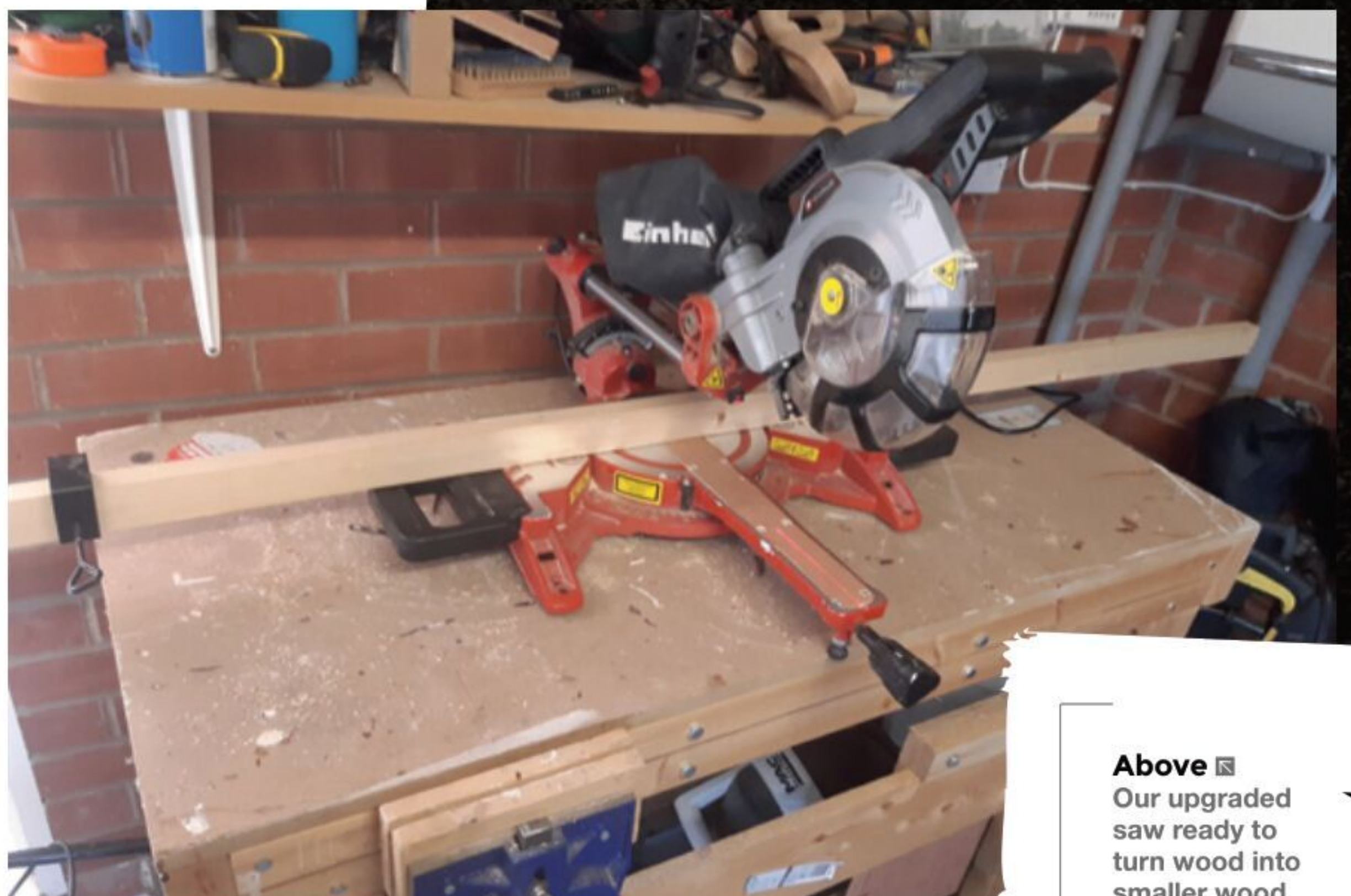

Above □ Our upgraded saw ready to turn wood into smaller wood

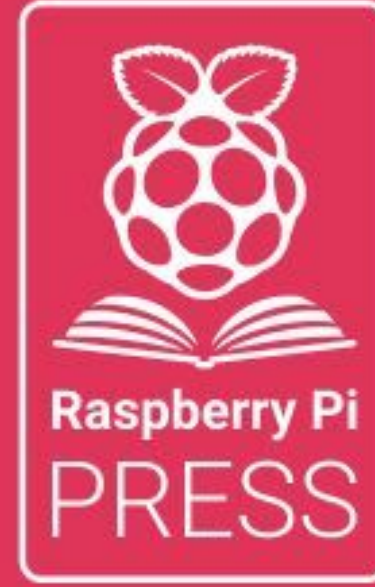

The
MagPi

HackSpace
TECHNOLOGY IN YOUR HANDS

CUSTOMPC

3 ISSUES FOR £10



FREE BOOK



hsmag.cc/hsbook

Subscribe to The MagPi, HackSpace magazine, or Custom PC. Your first three issues for £10, then our great value rolling subscription afterwards. Includes a free voucher for one of five fantastic books at store.rpipress.cc/collections/latest-bookazines
UK only. Free delivery on everything.

FORGE

HACK | MAKE | BUILD | CREATE

Improve your skills, learn something new, or just have fun tinkering – we hope you enjoy these hand-picked projects

PG
68

WEATHER STATION

Monitor our dying planet

PG
72

VINYL CUTTING

A CNC for thin materials

PG
80

CHOCO SYNTH

Make music with old food boxes

PG
86

DOUBLE HINGES

Mathematical magical marvels

PG
64

SCHOOL OF MAKING

Start your journey to craftsmanship with these essential skills

64 Bag clips

PG
92

CUSTOM PROTO BOARD

Lots of holes in any shape

PG
94

EASY STL EDITING

Make simple changes with PrusaSlicer

PG
98

COLOURFUL PCBS

Ditch the green rectangles

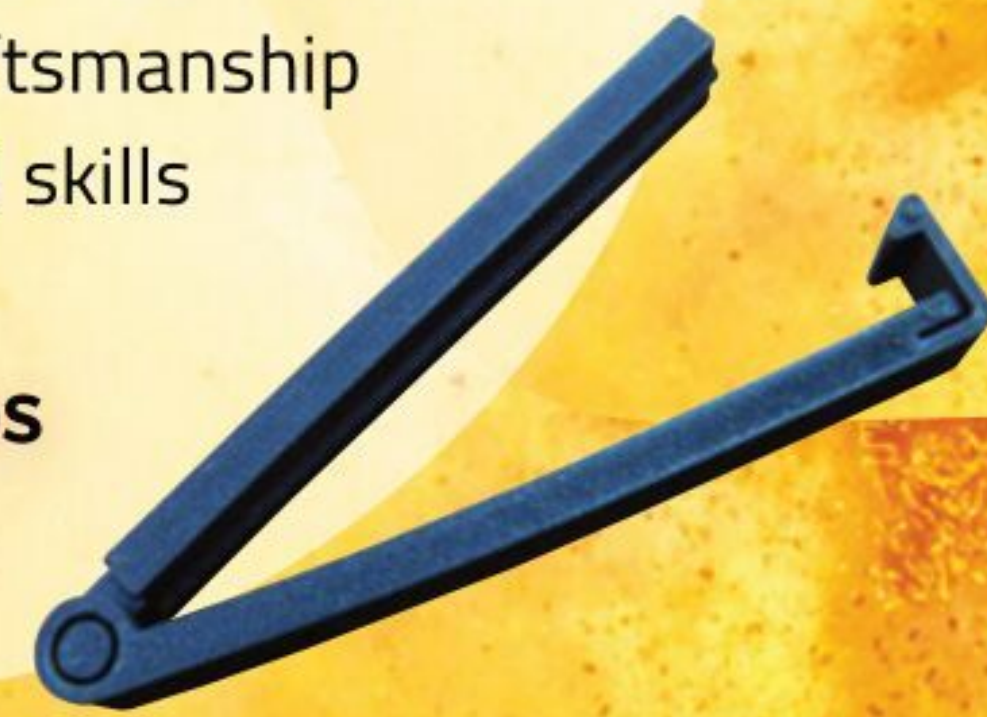

3D-printing bag clips

Secure your bags with style

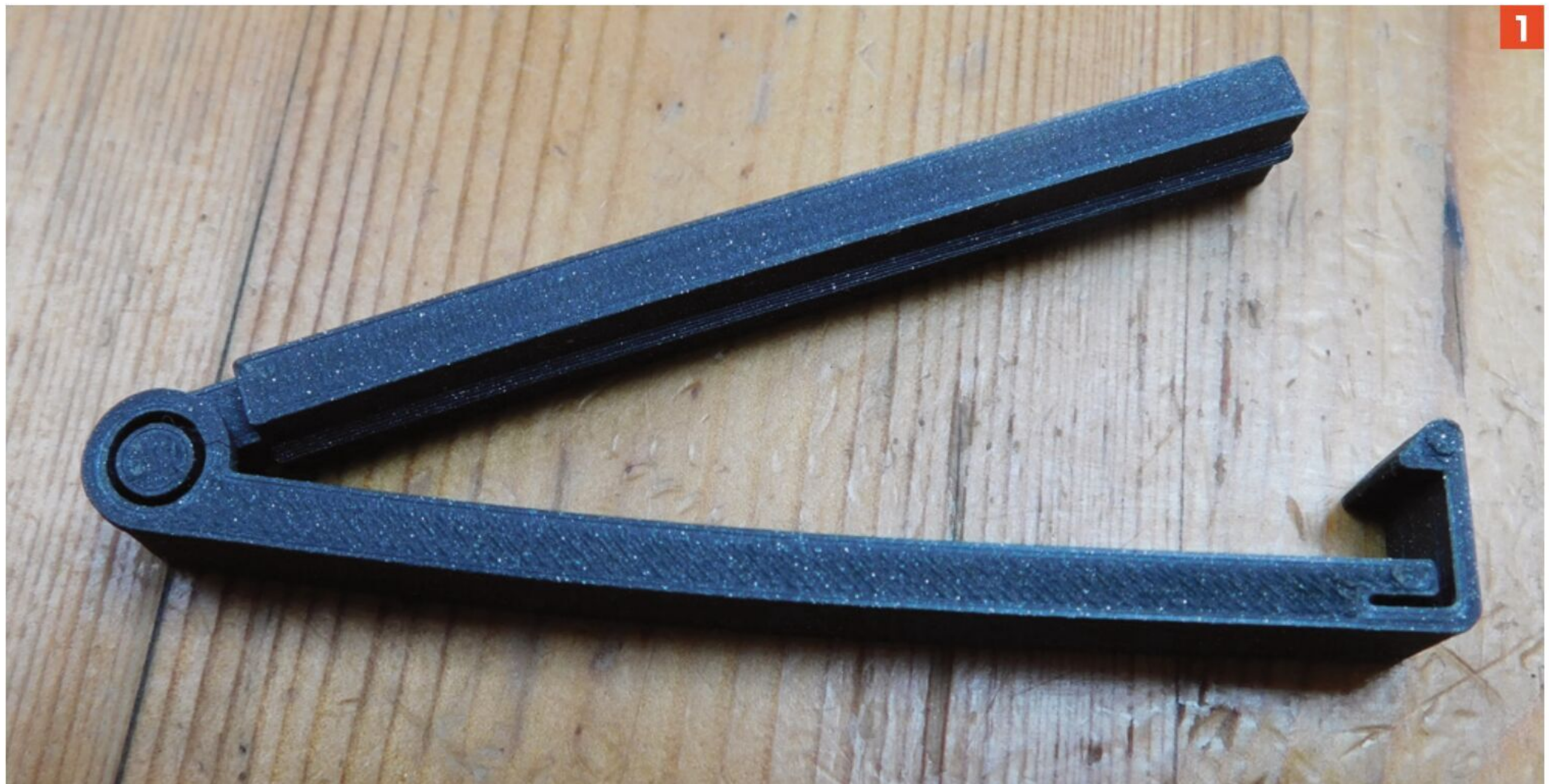

1 THE PRACTICAL ONE

1 **THE PRACTICAL ONE**
hsmag.cc/PracticalClip
This author has been using versions of this for about three years, printed in a variety of filaments, including some that are not particularly strong such as MetalFil. It's dependable, easy to print, and a great way to finish off the last bits of a spool.

1 **Above** ♦
This one has bent slightly with three years' use, but it still functions perfectly fine

2 THE BIG ONE

hsmag.cc/BigBagClip

Do you have large bags that you must scrunch up to get them to fit inside a regular bag clip? Yes, you can fold it over a few times and use a peg-style clip, but wouldn't it be better to just get a bag clip that fitted? The pre-bend in this design ensures it clips securely along its entire length, and it's a handy clip to have around the house.

Alas, physics is cruel, and the length of the arms on this means that you can put a lot of force on the hinge very easily. Our first one of these was broken by a well-meaning but over-enthusiastic four-year-old. We suspect the same fate may await its replacement.

3 THE SUPER-GRIPPER

hsmag.cc/CamClip

Most peg-like clips use a bending force to grip. This works but means that the gripping force is



2 Left ◊
No more awkwardly folding bags to make them fit in a clip

4 Below ◊
This is a pretty rubbish clip, but a great fidget toy

“ You can fold it over a few times and use a peg-style clip, but wouldn't it be better to just get a bag clip that fitted? **”**

proportional to the amount of force needed to open it. This gripper (and there are various spin-offs that make aesthetic changes, such as making it look like a dinosaur head) uses a cammed lever to activate the jaws which give it a good grip strength and locks it in place. It's kind of like a non-adjustable mole grip.

The downside of this design is that, when gripped, the jaws are a predetermined width apart. This may be the correct width for your bag, it may not be – there's no way of changing it.



4 THE ZIP GRIP

hsmag.cc/ZipClip

There probably is a practical purpose for this, but we can't think of it. This is just a fun way of making a bag clip. Be warned, though, there are perils in this print. It's designed for a perimeter width of 0.4 mm, which may not be the default in your slicer. Once printed, you need to push some short lengths of 1.75 mm filament into the holes to secure each segment. The tolerances are very tight to ensure a secure fit, and it's a bit tricky to get them in place without breaking the teeth. It might be worth printing a short section of the chain first to check that the tolerances are correct for your printer.

You can make this arbitrarily long by printing more chain and slotting it onto your zip. →

3 Left ◊
The classic Cam Clip is both functional and interesting to use





5 Right ♦ Turn bags into floppy jars with this screw-cap clip

6 Below ♦ This surprisingly functional clip combines a fun look and great clipping power



5 THE SCREW CAPS

hsmag.cc/ScrewCap

The thing about bag clips is that you have to unclip them. Yes, that may seem obvious, but it's also kind of annoying, especially with fragile bags prone to ripping when you try and get something out. Enter the screw-cap bag clips. These bag clips don't just seal the bag, they also provide an additional opening for you to access the contents. We've tested out two versions: one with a large opening for things like crisps, and one with a smaller opening for pourable goods.

6 THE ONE WITH TEETH

hsmag.cc/TeethClip

We get that this is a bit of a novelty, but as novelties go, this is a very practical one. There's a large spring action, so it closes very forcefully, and the wide grip of the mouth is effective at keeping bags shut. The pointedness of the teeth help it grip as well. A word of warning, though – it might seem funny to clip this on your finger to take a joke photograph, but the spring is vicious and it will hurt.

7 THE WORKSHOP ONE

hsmag.cc/BagClamp

G-clamps are a workshop staple (and despite what some people will tell you, they are clearly G-clamps and not C-clamps – note the descender that you screw to tighten the clamp), so why not use them in the rest of the house as well? This tiny clamp is perfect for keeping your bags shut tight, and it's very capable at this task. You can screw it much tighter than most clips can go, the spikes keep it in place on the bag, and it can work with a wide range of bag thicknesses.

The only down-side of this clamp is that it has a slight tendency to chew holes in thinner bags. ▣



PRINTABLES

This article is inspired by the Bag Clip contest on Printables. You can see all of the entries at hsmag.cc/PrintablesBagClips.

7 Left ▣
Bring a little bit of workshop chic to your kitchen

Build a weather station with a web dashboard



Phil King

Long-time contributor to *The MagPi*, Phil is a freelance writer and editor with a focus on technology.

@philkingeditor

With the Pimoroni Weather HAT and Sensors Kit, you can upload your data to an easily accessible web dashboard

While it's possible to build a DIY Raspberry Pi weather station from separate components and sensors, Pimoroni's Weather HAT makes the process far simpler and easier. As well as on-board BME280 (temperature, pressure, humidity) and LTR-559 (light) sensors, the HAT features a Nuvoton microcontroller with a 12-bit ADC to read analogue signals reliably from external weather sensors connected via standard RJ11 ports. It even has a mini colour LCD screen to display readings.

The Weather Sensors Kit comprises three meteorological sensors: an anemometer to

measure wind speed, a wind vane for direction, and 'tipping bucket' rainfall gauge. Alternatively, you may already have similar sensors or be able to source them elsewhere, but you'll need a couple of RJ11 connectors to plug them into the HAT – with wind speed and direction sensors routed through one connector. Either way, let's get started.

You'll Need

- ▶ Raspberry Pi
- ▶ Raspberry Pi OS
- ▶ Weather HAT + Weather Sensors Kit
magpi.cc/weatherhat



▲ Our weather station's cables go into the garage where a Weather HAT-equipped Raspberry Pi is located – an external weather-proof box would be better, however

01 Set up Raspberry Pi

If you don't already have a recent version of Raspberry Pi OS written to your microSD card, use Raspberry Pi Imager (magpi.cc/imager) to do so from another computer. While you're at it, click the cog icon in Imager to access the Advanced Options. Here you can enable SSH (useful for remote operation later), set a username and password, and configure your WiFi connection. You may also want to change the hostname to something like 'weather.local', to make it easier to identify your weather station Raspberry Pi on the network (rather than using its IP address).

02 Mount the HAT

With your Raspberry Pi powered off, mount the Weather HAT on its GPIO header, with the body of the HAT over that of Raspberry Pi. You can use any Raspberry Pi model with a 40-pin header; we chose a Raspberry Pi Zero W for our setup and

connected to it via SSH rather than using a monitor for setup. You can add standoffs and screws through the mounting holes next to the header (and the others if using a full-size Raspberry Pi) to secure the HAT more firmly.

03 Install the software

With Raspberry Pi connected to a monitor and keyboard, open a Terminal window. Alternatively, access it remotely via SSH from another device. Enter the following commands to install the Weather HAT library:

```
git clone https://github.com/pimoroni/
weatherhat-python
cd weatherhat-python
sudo ./install.sh
```

This will automatically enable the I2C and SPI interfaces and install some additional software required for the HAT to work. In addition, the folder will include an **examples** subfolder of code examples. To be able to run these, you'll need to install some extra fonts and dependencies:

```
sudo pip3 install fonts font-manrope pyyaml
adafruit-io numpy
```

Note: If you're using the Lite version of Raspberry Pi OS, you may also need to install some additional software before the commands above will work. To do so, enter:

```
sudo apt install python3-pip git libatlas-
base-dev
```



▲ Mounted on a Raspberry Pi Zero (hidden beneath), the Weather HAT has on-board BME280 and light sensors

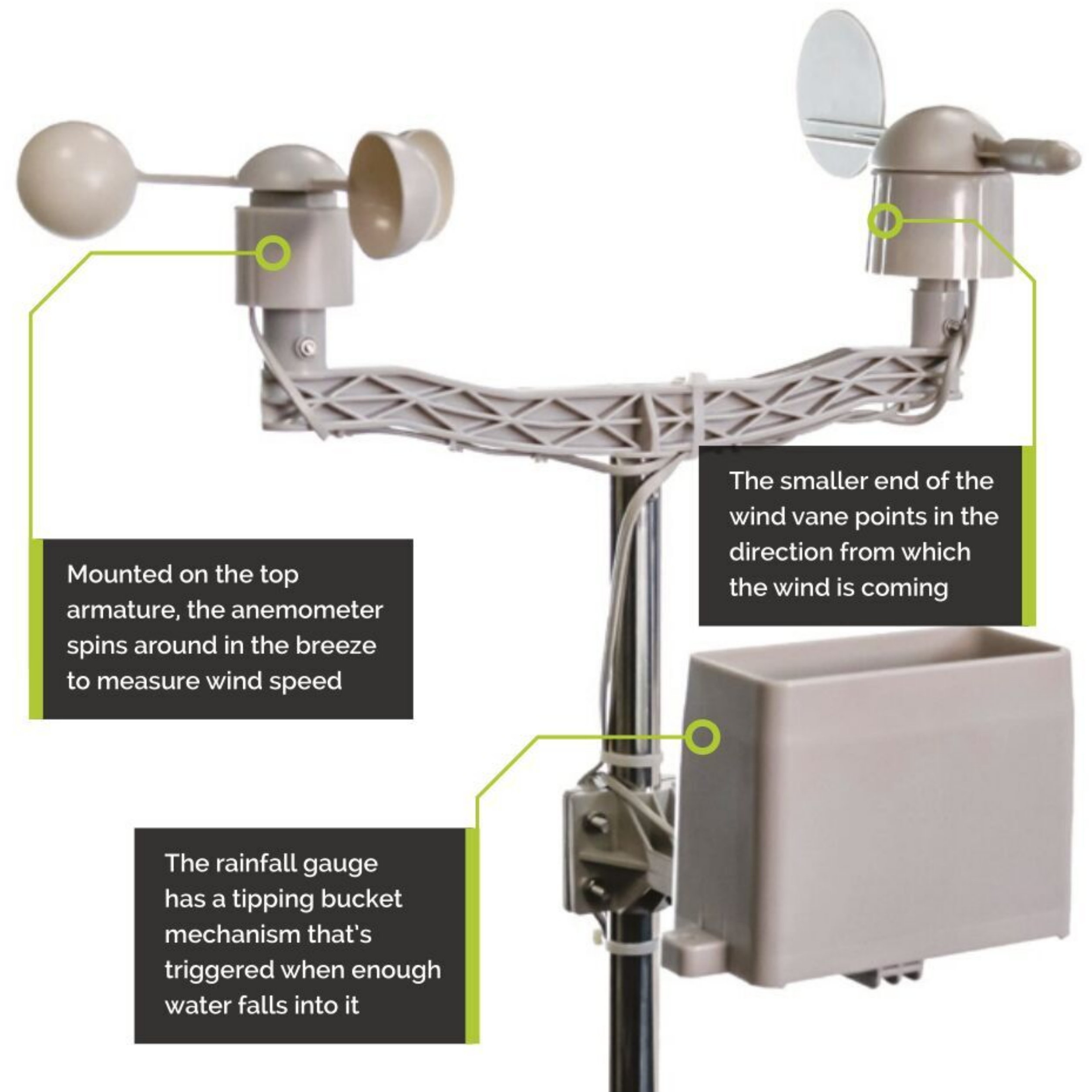

Mounted on the top armature, the anemometer spins around in the breeze to measure wind speed

The smaller end of the wind vane points in the direction from which the wind is coming

The rainfall gauge has a tipping bucket mechanism that's triggered when enough water falls into it

Now reboot Raspberry Pi with `sudo reboot`, for the changes to take effect.

04 Initial testing

With the software installed and Raspberry Pi rebooted, let's do a quick test of the HAT's on-board sensors. Change directory to the **examples** folder and run the main Python code demo:

```
cd weatherhat-python/examples
python weather.py
```

The default screen on the LCD will show several sensor readings. Since the external sensors are yet to be connected, you will only see those for the on-board BME280 and LTR-559 sensors for now: temperature, pressure, humidity, and light. We'll test the external sensors following assembly.

05 External sensors assembly

First, slide the two metal tubes together to make the mast. Then add the longer armature to the top of the mast, securing it with a screw. Mount the anemometer and wind vane securely on either side of the armature. The rain gauge fits onto a shorter armature further down the →

Top Tip

Air & light

If using a weatherproof enclosure for Raspberry Pi, make sure it's well-ventilated from below. A transparent lid will also enable the light sensor to work.

► Our final Adafruit weather dashboard, using line charts, gauges, and a live stream for all feeds. You can design yours how you want it

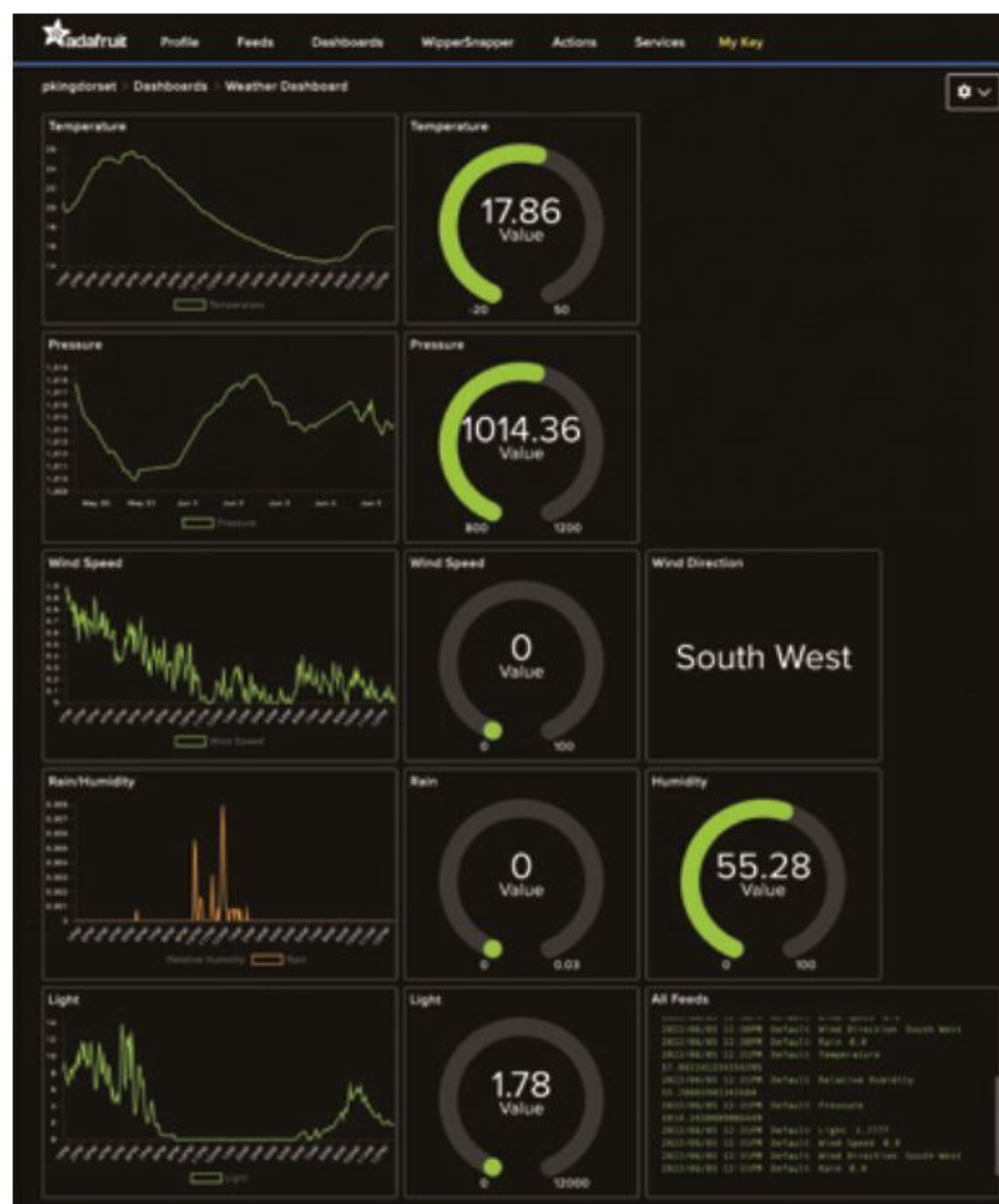

most, clear of the other sensors so they don't interfere with its operation. For more detailed build instructions, see SparkFun's assembly guide: magpi.cc/weatherbuild.

The wires from the wind sensors can be kept neat using the built-in cable clips on the top armature. The anemometer's RJ11 connector fits into a port on the underside of the wind vane. As you'd expect, the rain gauge connector goes into the 'Rain' port on the Weather HAT, while that coming from the wind vane goes into the 'Wind' port – note that this cable is thicker, as it carries four wires (for both wind sensors) instead of two.

06 Test again

With the external sensor assembly complete, and the connectors inserted into the correct ports on the HAT, let's test they're all working correctly.

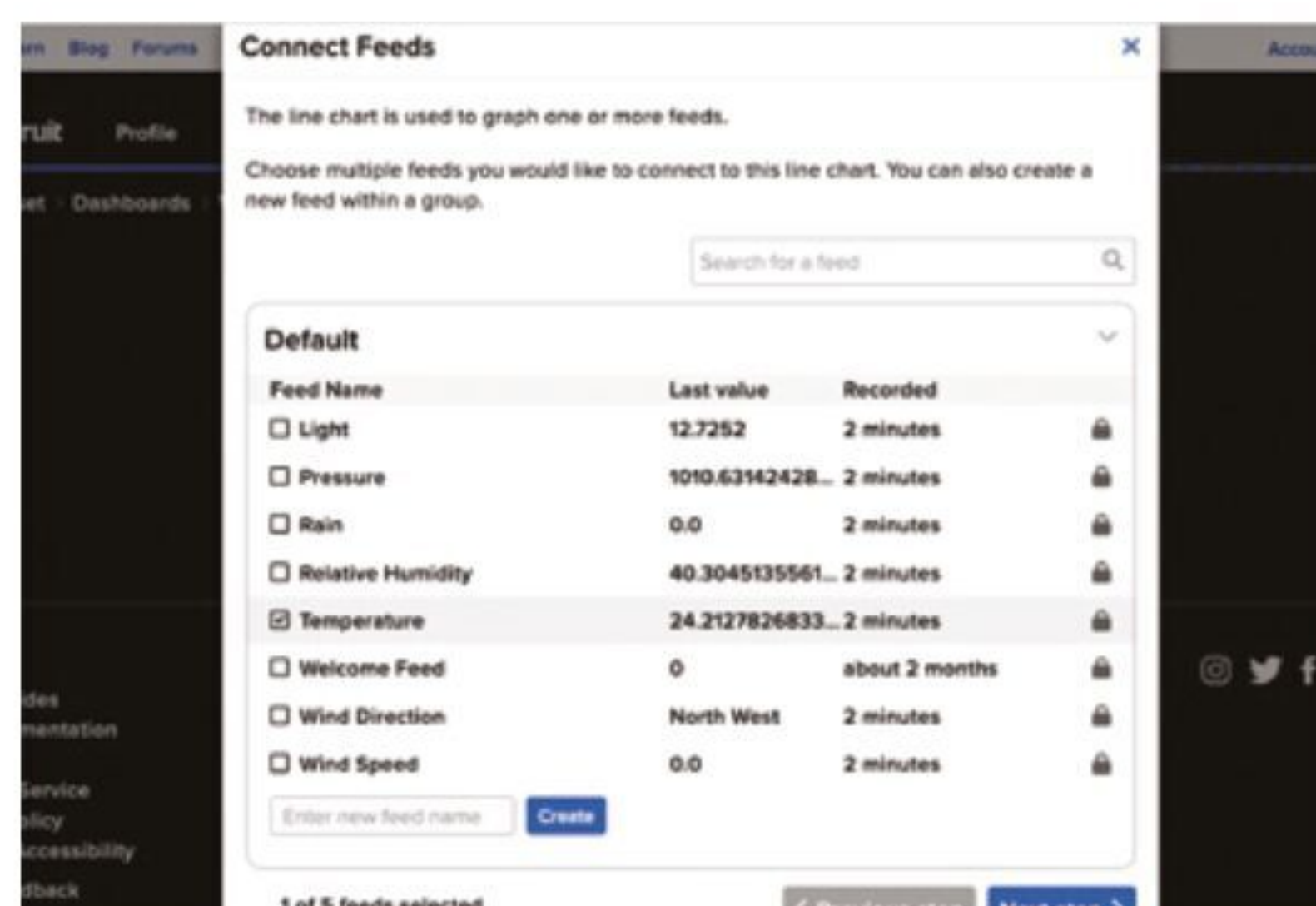

▲ Choose a block type to add to the dashboard, then select one or more sensor feeds for it

Run the **weather.py** code example, as in Step 4. This time, you should see two extra readings at the top of the LCD's default screen: for rain (in mm/s) and wind (speed in m/s). Try spinning the anemometer and you'll see the wind reading increase. Similarly, try tilting the rainfall gauge up and down to make the internal bucket tip (you'll hear a clicking noise) and you should see the rain reading rise.

Pressing the X button on the HAT will change the numerical readings to graphs. Repeatedly pressing A will show specific displays for different sensors. With the wind display selected, test the wind vane by rotating it to different positions; the graph should change to show the direction.

07 Taking it outside

There's little point getting weather readings from inside the house, so it's time to take our weather station outdoors. You could site the external sensors mast by sticking it firmly into the ground, or securing it to a downpipe with the supplied jubilee clip (gear clamp). Alternatively, as we did, you can use standard zip cable ties to secure the sensor mast to a garden fence post. You could even use a TV aerial mast to mount it on the side of a garage. Ideally, try to avoid siting the weather station too close to trees or other obstructions that may affect the wind and rain readings. Before securing it firmly in place, check Step 8 to calibrate the wind vane.

Since the sensor cables are roughly 3 m in length, you'll need to position Raspberry Pi fairly nearby unless using cable extenders. Naturally, you'll need to protect it from the rain, so you could use a standard weatherproof case or, even better, a Stevenson screen for better ventilation. We simply ran the cables through a window to Raspberry Pi in our garage, although this does give inflated temperature readings on hot days.

08 Wind vane calibration

To obtain an accurate compass direction reading from the wind vane, you'll need to make sure it's pointing north when its reading is north. To do so, use a standard compass, or an app on your smartphone, to determine in which direction north is.

The wind vane sensor has four barely visible protrusions on its body. When the shorter end of

Top Tip

Power & WiFi

You'll need a continuous power supply for Raspberry Pi, from an indoor or dedicated outdoor mains socket. You may also need a WiFi range extender if it's located far from your router.

the vane is pointing toward the protrusion nearest where the main cable (going to the HAT) comes out, it's pointing north. You can double-check this by running the **weather.py** demo code and rotating the vane so it reads north.

Now rotate the whole mast so that the north end of the wind vane is actually pointing north. Secure it tightly in place so it can't move out of position. You will also want to check that the rain gauge is level, by ensuring that the small spirit level bubble on it is centred.

09 Set up Adafruit IO

While there are numerous options for logging and charting your data locally or online, the easiest way is to use the Adafruit IO code example to set up a web dashboard that you can view from any device.

First, point a web browser to **io.adafruit.com**, click Get Started for Free, and enter your details for a free Adafruit IO account. Click on My Key to see your username and active key. On Raspberry Pi, go to the **examples** folder and edit the code file with:

```
sudo nano adafruit-io.py
```

Now alter the following lines by adding your key and username between the single quote marks:

```
ADAFRUIT_IO_KEY = 'YOUR AIO KEY HERE'
ADAFRUIT_IO_USERNAME = 'YOUR AIO USERNAME HERE'
```

Press **CTRL+X**, then **Y** to exit and save the file. Then run it with:

```
python adafruit-io.py
```

This will automatically create a Weather dashboard in your Adafruit IO account and populate it with the sensor feeds. Now, you just need to design the web dashboard.

10 Design dashboard

In your Adafruit IO account, open up the weather dashboard. Click the cog icon and Create New Block. Let's start with a temperature graph: select the Line Chart option. In the list of sensor feeds, tick Temperature and then click Next Step. Enter a block title for it, e.g. 'Temperature', leave



the other options unchanged, and click Create Block. It will now appear on the dashboard.

Let's add a real-time temperature gauge. Click the cog and Create New Block, then select the Gauge option. Tick the Temperature feed again and click Next Step, then give it a title, alter the min and max values to your preference (e.g. -20 and 50), and add 'Celsius' as the label. Click Create Block and it'll appear on the dashboard, under the chart.

Using the same process, continue to add dashboard widgets for other sensor feeds, to your preference. We also added a Stream widget to show all the live sensor feeds. You can create a chart for multiple feeds if you like, such as rain and humidity (as we did); you can then select to show/hide each feed by clicking its colour-coded rectangle in the chart key.

To reposition blocks, click the cog icon and Edit Layout, then click and drag the blocks around. You can also click the cog icon on a block to edit it, and alter the history duration for charts. When happy, click Save Layout.

▲ Use a compass or phone app to ensure the wind vane is aligned correctly to north when reading north

11 Run from boot

With your web dashboard set up and the data uploading correctly, you'll want to get your **adafruit-io.py** script to run automatically on bootup. To do so, enter **crontab -e** and add the following line at the bottom of the file:

```
@reboot python /home/pi/weatherhat-python/examples/adafruit-io.py &
```

Press **CTRL+X**, then **Y** to save it. Now, even if the power goes off temporarily, when your Raspberry Pi reboots, the script will start running again and continue uploading data. □

THE MAGPI



This tutorial is from in The MagPi, the official Raspberry Pi magazine. Each issue includes a huge variety of projects, tutorials, tips and tricks to help you get the most out of your Raspberry Pi. Find out more at **magpi.cc**

Vinyl cutting: the basics and beyond!

Vinyl cutters are amazing machines, but at first glance you might imagine they are only for making stickers. In this two-part tutorial, we'll look at a broad range of activities that the vinyl cutter can help with!



Jo Hinchliffe

@concreted0g

Jo Hinchliffe is a constant tinkerer and is passionate about all things DIY space. He loves designing and scratch-building both model and high-power rockets, and releases the designs and components as open-source. He also has a shed full of lathes and milling machines and CNC kit!



In the heady realms of hackspaces, there are many headline machines. Often, people are lured in with an interest in 3D printing, and then possibly they discover the wonders and convenience of laser cutting. Maybe their eye catches the CNC router at some point, or the lathes and milling machines, or some robotics project pulls them into a life of electronics learning and experimentation. One machine that sometimes gets overlooked in all this glamour is the humble vinyl cutter but, with some exploration and tinkering, these stalwart machines are capable of much more than we might imagine.

The basic premise of the vinyl cutter is simple: we feed it some lines to follow and it follows them with a blade to create accurate cuts. The most obvious use (clue is in the name) is cutting sticky-back vinyl. Our machine of choice is an old Silhouette Cameo Mk1, (Figure 1), which is a small but solid workhorse of a vinyl cutter that can be found quite cheaply on the second-hand market. The modern version of this vinyl cutter, the Mk4, is very much updated with Bluetooth, app control, multiple blade slots and more, but is essentially the same machine. The Silhouette cutters come with some Windows software to create and send files to the cutter but, wonderfully, and unlike

Figure 1 Our trustworthy older Silhouette Cameo Mk1 cutter loaded with some vinyl and a cutting board, ready for work

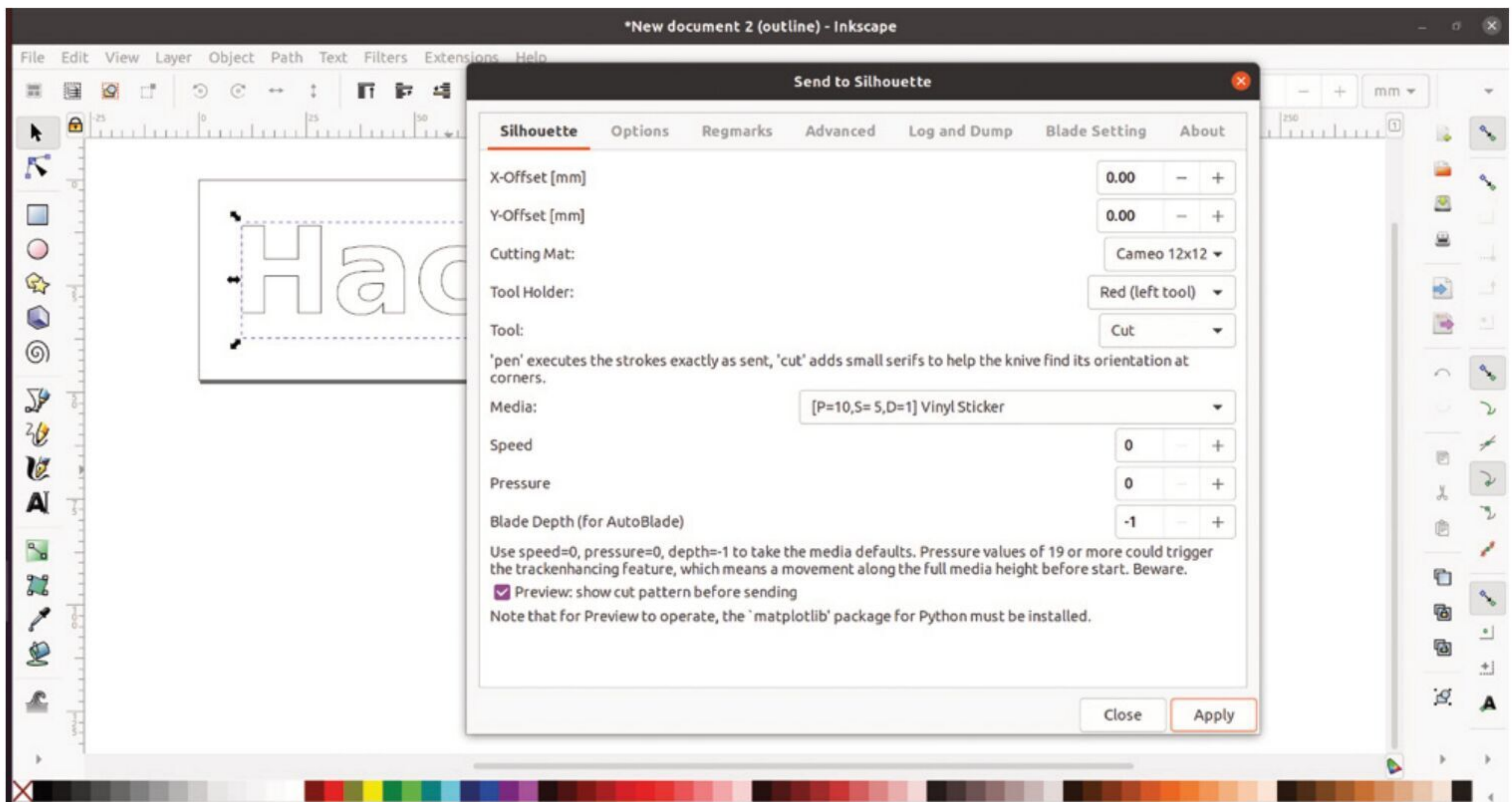

some of their contemporaries, they can be driven by other means. We drive ours using an excellent open-source Inkscape extension (hsmag.cc/Silhouette), which allows us to draw in Inkscape and then directly send the cut file to the machine from there. Note that most of the projects and ideas we will look at in this two-part miniseries can be made on any vinyl cutter with a decent blade!

A STICKY SITUATION

The Silhouette cutters can work either directly feeding a roll of vinyl into the machine, which is useful if you want to do a longer design, or more commonly for small projects, people mount material to be cut onto a sticky backing board or cutting sheet. These sheets are a stiffer plastic covered in a medium-tack adhesive, so you should be able to attach a piece of vinyl with backing onto them and remove it. This is a great approach as it means you can, and should, keep all your scrap offcuts of vinyl, as you can align even a tiny scrap and make accurate cuts out of it, really minimising waste.

As an example of a basic sticker cut, we set up some text in Inkscape. With some text written and a font chosen, we needed to select the text and then click Path > Stroke to path. We then sent it to cut on the machine: with the text created, we clicked Extensions > Export > Send to Silhouette. This

launches the inkscape-silhouette extension and we get a window asking us to choose the settings we wish to use (Figure 2). The inkscape-silhouette plug-in has a good collection of suggested settings for many materials – we simply used the ‘sticky vinyl’ setting. Note that the settings are made up of a Depth, Speed, and Pressure value and that you don’t have to use a preset – you can insert these values directly. This is great for experimentation with different materials.

We next stuck a piece of standard vinyl onto the backing sheet and loaded the backing sheet into the machine (Figure 1). We then clicked the Apply button on the inkscape-silhouette extension and then, after checking the preview, clicked ‘Cut’ and the machine

sprang to life and cut our lettering. Once cut, you click the Unload button on the machine to release the cutting mat.

Once our lettering was cut, we unloaded the backing sheet and removed the cut from it.

It’s often said that the best way to remove work from the cutting mat is to pull the mat away from the work rather than the work off the mat, as this lessens the amount of curling of the workpiece. With the piece removed, we weeded out the parts we didn’t need (Figure 3). The next issue we faced was how to move the sticker off the backing sheet and onto the project whilst keeping all the separate parts aligned. For this, we need some transfer tape. Transfer tape is a clever →

“ The basic premise of the vinyl cutter is simple: we feed it some lines to follow and it follows them with a blade ”

Figure 2 The inkscape-silhouette extension settings screen, with a range of presets to get you started, but with the option to insert your own values as you experiment

YOU’LL NEED

- ◆ Access to a vinyl cutter
- ◆ Sticky-back vinyl
- ◆ Heat transfer vinyl
- ◆ Transfer tape
- ◆ A squeegee or a small piece of stiff plastic
- ◆ A weeding tool something like a craft knife, fine tweezers, or a dental pick



Figure 3 ♦
Our design is now weeded and we are applying transfer tape to allow us to lift the design off the backing, whilst keeping everything aligned

BLADE RUNNER

The Silhouette cutters, as standard, have an 'auto blade' function where the Silhouette blade is twisted in a series of clicks to extend or retract the blade. These work well, but they are quite expensive and, if you become addicted to vinyl cutting, you might want to use a more affordable blade setup as you will blunt blades reasonably often. The most popular after-market option is the CB09 blade holder and blades. This blade holder works directly with the Silhouette Mk1 but needs a small adapter to fit the Cameo Mk4. There is a commercial one available, or indeed, there are lots of examples of 3D-printed adapters to download and print. The CB09 has lots of support and users, so there are heaps of discussions and tutorials to be found about using them with a wide variety of machines and materials.

The CB09 holders have exchangeable blades and are often sold with multiple blade packs. These small blades are sold quite cheaply in a range of different angle geometries, which is great for experimenting with cutting different materials. To set up a CB09 blade, you unscrew the black plastic cover, insert the blade and spring, and reattach the cover. Using the upper twist section, you can turn to raise and lower the amount of blade sticking out through the lower plastic section. It's hard to do this by eye, as the amount of blade is quite tiny. Our approach is to grab a spare scrap piece of your intended material and, using little pressure, similar to how much you apply with a ballpoint pen, move the blade across the material. You are aiming to cut through the top layer of the material cleanly, but not cut into the backing material. Once you think you are close, you can dial in perfect results by running a few test cuts on the machine. Keeping a running diary of your settings is also useful. If you cut a lot of one particular material, it is sometimes worth buying a couple of CB09 blade holders, and leaving one permanently set up for your main material.



tape where, similar to the cutting mats, the tackiness is quite low. The concept is that the low-tack tape has enough stick to lift the vinyl off the backing paper, but the adhesive on the vinyl, when applied to the target project, will be stronger than the transfer tape, allowing you to remove it. The caveat with this though is that, depending on the material you are applying the vinyl to,

“ If the vinyl starts to lift when you remove the transfer tape, you can put it back down and work the vinyl some more ”

you might need to really work and press down the vinyl design before removing the backing tape.

Applying the transfer tape, we want to get it as neat and as flat as possible, although if it does have small creases or bubbles in the transfer tape, this often won't affect the layup. Using a 'squeegee' can help you sweep the transfer tape onto a design cleanly. Peel off the design with the transfer tape and apply it to your project. Using the squeegee, really push and rub the vinyl onto the project, and then slowly remove the transfer tape (**Figure 4**). If the vinyl starts to lift when you remove the transfer tape, you can put it back down and work the vinyl some more.

Of course, many times, we will want to have a multicolour and, therefore, multilayered design. The most challenging aspect of multilayer vinyl work is not usually the design but, more often, the laying and transferring of the layers to the piece we are working on. There are a couple of really useful and simple approaches to doing multilayer designs that work in

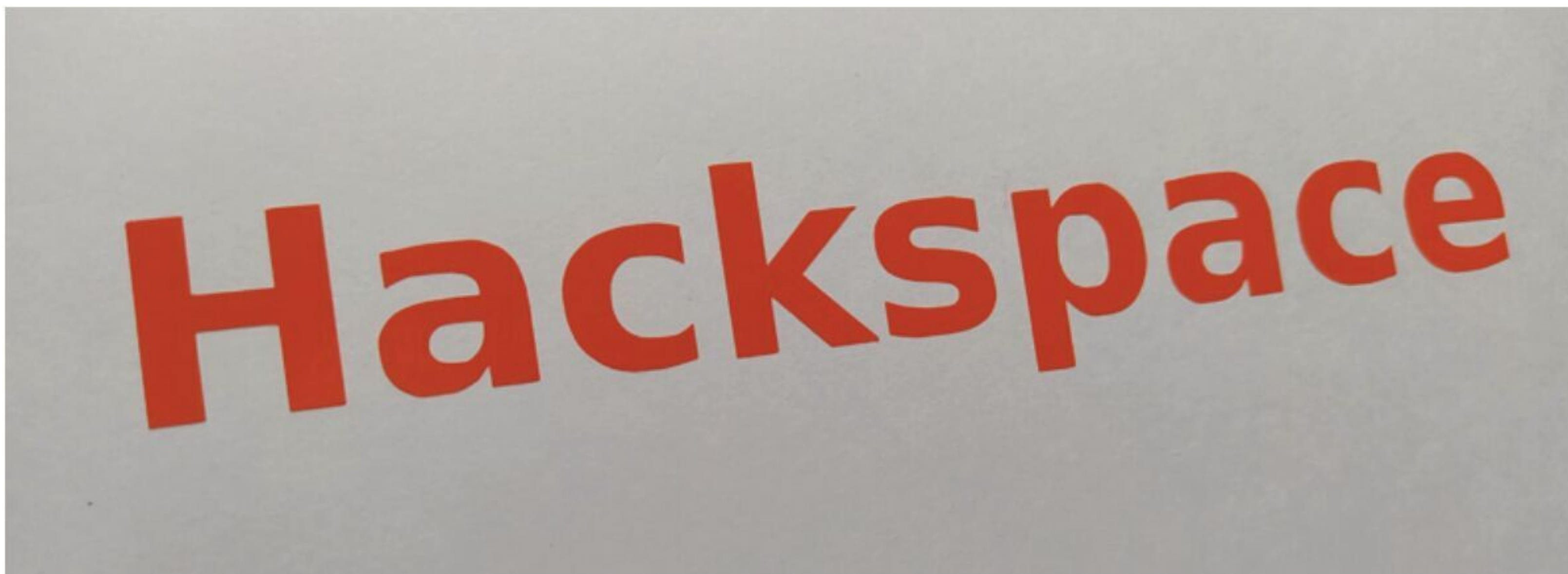

Figure 4 ♦ Having pressed the vinyl down onto our target and worked/rubbed the vinyl, we carefully peel away the transfer tape to reveal our sticker

two different ways – the first allowing the entire new layer to move around, and the second allowing for precise alignment before actually committing to stick the new layer down.

SLIDING AROUND

The first method is wet layup. Wet layup allows you to reposition the vinyl, and also is very useful if you struggle with air bubbles under your vinyl. You need to make up a very weak soap and water mix – around one or two drops of washing-up liquid to a mugful of water is about right. It's easier to use an atomiser spray bottle for the soapy water but, if you can't find one, you can use a drenched dishcloth to apply some of the mixture to the area you want to add the vinyl to. You can now take your vinyl cut, on the transfer tape, and place it gently onto the area. You'll notice that it doesn't stick and you can move it until you are happy with the positioning. Once happy, you then use a squeegee and apply firm pressure to force the water out from under the design. Of course, you can use the wet layup approach to add extra layers over the top of earlier ones.

The second approach useful for multilayer designs is using small registration blocks you add to your vinyl cut designs. As an example, we made a design which is

simply an outer circle background with a segmented circle on top (**Figure 6**). In the design file, the larger circle is drawn first, and then two rectangles are positioned at the top of the design on either side. The position and size of the rectangles are not particularly important but, once you have placed them in the design, you need to ensure you don't move them between cutting layers. We then draw the second smaller circular section with the quarters and centre it to the first circle. Using the inkscape-silhouette plug-in, we can, in Inkscape, multi-select the outer circle and the two rectangles and send those as a cut job to the Silhouette. Next, we select the inner section and the two rectangles and send that as the second job to the vinyl cutter. Weed both the cuts and apply transfer tape to the second layer cut, the smaller circle, including the small rectangles. We can now use a sheet of greaseproof paper in between the first and second cuts to stop the majority of the second layer from sticking →

WEEDING OUT

If your vinyl cut design is a single solid logo that just has an outside line, then you can peel off the surrounding waste vinyl and you are ready to transfer your design. Often though, designs, like many of our examples, have internal parts that need to be removed before we can use our cut piece. This removal of internal parts is referred to in the vinyl cutting community as 'weeding'. Some people find weeding a pain; others almost seem to find it therapeutic! Whatever your feelings, it's worth experimenting with different tools as a weeding aid. Common choices include tweezers, a dental pick, pins, or a craft knife. Whatever your weapon of choice, it's a skill that you will improve and get quicker at!



QUICK TIP

Selecting view-display mode and changing from 'normal' to 'outline' in Inkscape gives you a clear image of the vector paths a vinyl cutter will follow.

Figure 5 ♦ A simple but challenging multilayer design with two concentric circular elements; using sacrificial rectangle blocks and greaseproof paper can help us align the designs

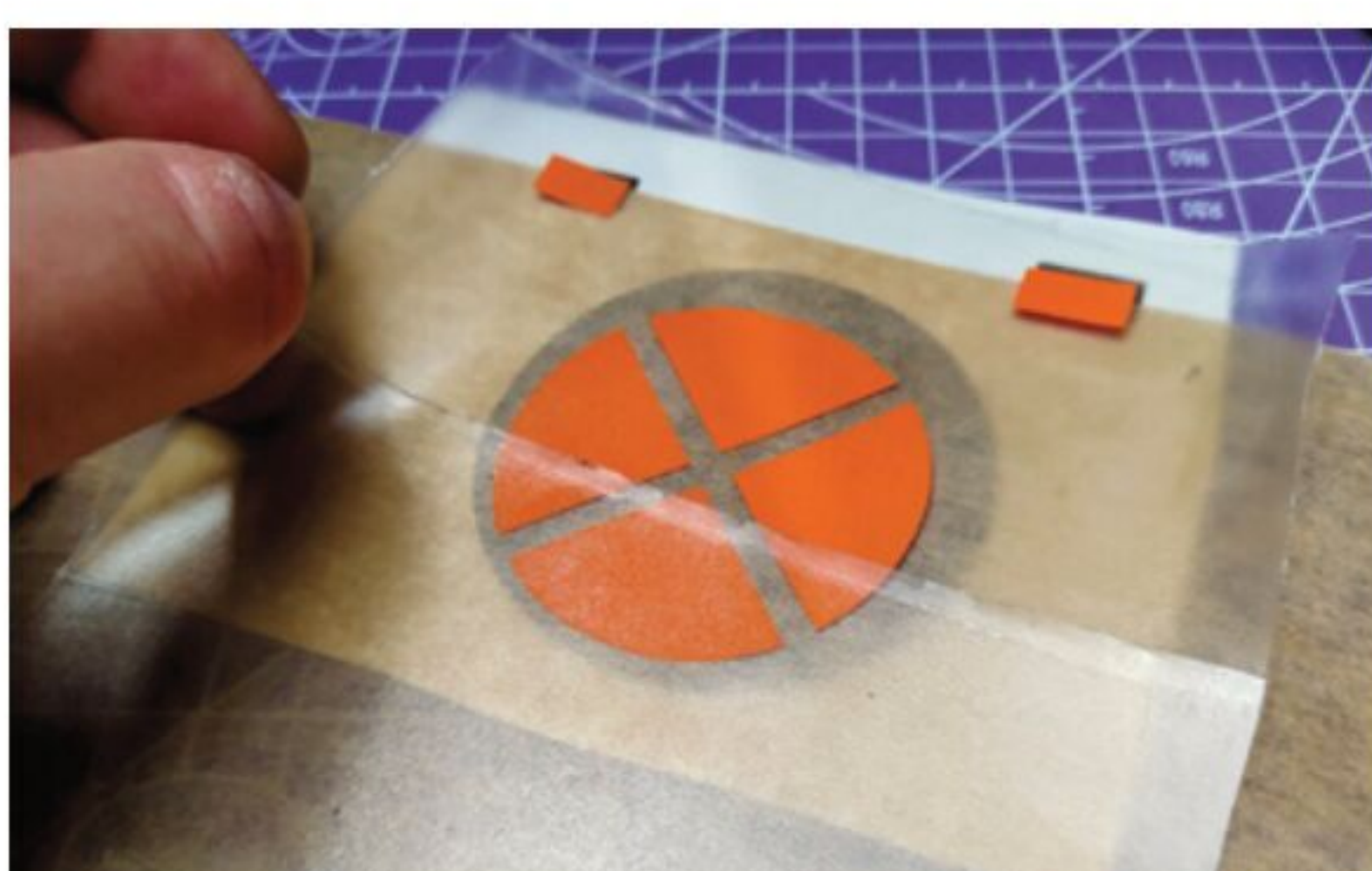

TUTORIAL



Figure 7 ♦ Using sticky-back vinyl to create a screen print simplifies the screen printing process, and makes the screens last longer and easier to reuse



Figure 6 ♦ Having aligned the layers using the rectangles, we remove the greaseproof paper, cut off the rectangles, and can then lift and place the full design

Figure 8 ♦ Ironing on a small HTV logo to a piece of canvas, we are using a modeller's iron, but a household iron works just as well

to the first (**Figure 5**). You can see through the greaseproof paper well enough to check the second layer against the first. Leave a tiny part of the rectangles uncovered by the greaseproof paper, and you can tack the top layer to the bottom layer very slightly, and then place the top layer down on the greaseproof paper. This allows you to repeatedly move the top layer and reposition it, aiming to get the registration rectangles perfectly aligned. Once you are happy with your positioning, you remove the greaseproof paper and squeegee down the top layer. Finally, you can then cut off the rectangles and lift the entire design off the backing with the transfer tape (**Figure 6**).

Standard vinyl isn't limited to just stickers. We can use vinyl for all kinds of interesting approaches when we consider the vinyl as a stencil or mask. One area

that we have been exploring is combining vinyl cutting with screen printing approaches (**Figure 7**). Classically, screen printing has used a photosensitive emulsion painted onto a fine silk mesh screen. You would then create a mask of the design you wanted to end up with, which you place over the emulsion-covered mesh. You would then expose this in a light box which makes the uncovered emulsion cure. Then, you wash away the uncured emulsion to get your silkscreen. Using a vinyl cutter gives us a much more direct and reusable way to mask off silkscreens. Simply vinyl-cut your design, weed, and transfer the design onto your silkscreen using transfer tape. We instinctively placed the vinyl on the underside of the screen, which means that you may need to mirror your design before you cut it, although we accidentally forgot one time and, just





QUICK TIP

With the wet layup method, keeping a small area free of water at one edge of the design allows you to tack the design in place using the transfer tape.

for fun, decided to try it with the non-mirrored vinyl cut on the top side of the screen, and it also worked well!

BRING THE HEAT

Another classic use of a vinyl cutter is to cut heat transfer vinyl, also known as HTV. HTV is an excellent material which comes in a wide range of colours and patterns, and you can cut the vinyl and then use heat – either a snazzy heat press, or a common household iron – to permanently fix the vinyl onto fabrics. Most HTV has a shiny side and a duller side. The dull side is the one we need to cut; the shiny side is actually a thick heat-resistant transfer tape that is already attached to the HTV. The shiny-side transfer tape is tough, so if you accidentally try to cut that side, it won't work and you'll be putting a lot of wear on a blade.

HTV, often, is similar to cut as sticky-backed vinyl, so similar cut settings typically work well. One thing to note is you will need to mirror your design, as essentially, you are cutting HTV from the underside of the design due to the way it is loaded into the cutter.

Mounting a piece of HTV onto the backing sheet, we cut a simple dog logo and, similar to regular vinyl, we weeded the extraneous HTV off the design. This particular HTV needed to be applied with an iron at 160°C. We used a small modeller's iron that we have – but a regular iron will suffice – with the iron set around halfway between the wool and cotton settings. We always protect our iron by putting a sheet of

greaseproof baking paper between the iron and the design (Figure 8). Once the design was pressed on, we allowed it to cool down before peeling off the transfer tape. This can vary, with some brands of HTV wanting you to peel the transfer film whilst hot. Again, when you get some new material, it's worth running a couple of experiments to work out the settings and approaches that work for you. □

UP NEXT

Next issue, the second part of this miniseries will look at more experimental uses for vinyl cutters. These will include looking at cutting metal foils to create embedded circuits in objects, creating PCBs using the vinyl cutter, etching glassware, cutting fabrics, pen plotting with a vinyl cutter, and much, much more!



Above □ Our simple example in the foreground and a multilayer hat in the background with an HTV design

Wireframe

Join us as we lift the lid
on video games



Visit wfmag.cc to learn more

THE OFFICIAL Raspberry Pi Beginner's Guide

The only guide you
need to get started
with Raspberry Pi

Inside:

- Learn how to set up your Raspberry Pi, install an operating system, and start using it
- Follow step-by-step guides to code your own animations and games, using both the Scratch 3 and Python languages
- Create amazing projects by connecting electronic components to Raspberry Pi's GPIO pins

Plus much, much more!

£10 with **FREE**
worldwide delivery

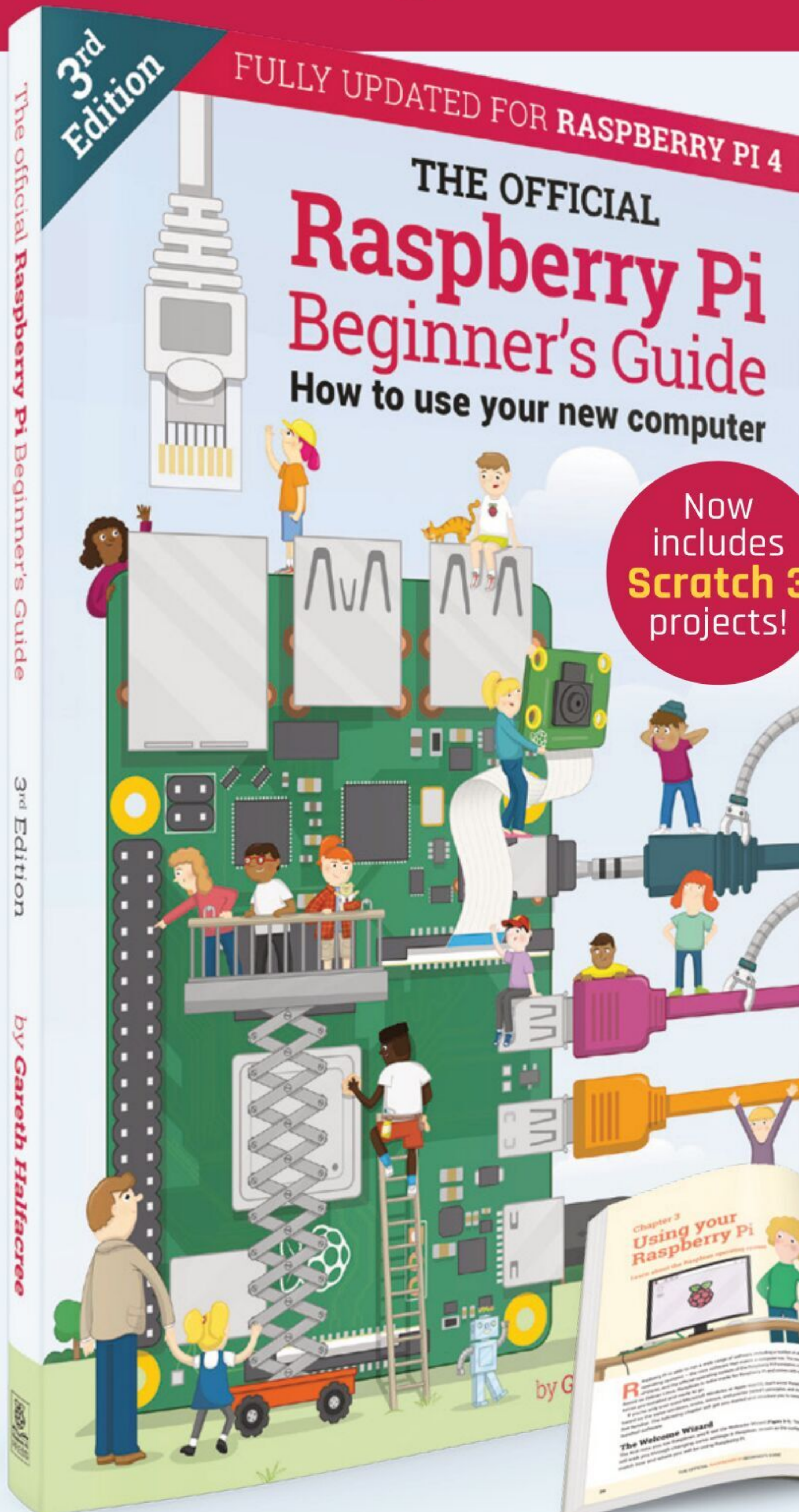

Buy online: magpi.cc/BGbook

Raspberry Pi-powered music synthesizer with light display

Make a synthesizing soundbox with a light display and controllers



Rob Miles

@robmiles

Rob Miles has been playing with hardware and software since almost before there was hardware and software. You can find out more about his so-called life at robmiles.com and follow him on Twitter at [@robmiles](https://twitter.com/robmiles)



Turn a Raspberry Pi into a powerful sound synthesizer with stereo speakers, encoder inputs, and a synchronised pixel display.

The Raspberry Pi makes a fine sound synthesizer when running programs such as Pure Data. This project adds speakers, a couple of rotary encoders, and a pixel array to turn a Raspberry Pi into a portable 'synthbox'. You can connect MIDI controllers to change the sounds and create looped patterns. **Figure 1** shows the synthbox, with the Pico Midi Crackers controller, and Pico Midi CheeseBox.

You can play tunes on the CheeseBox keys and the synthbox pixel display will dance along with each

note. You can scroll inspiring messages across the pixels. The CheeseBox has three rhythm tracks; notes on these tracks will cause the display to flash along with the beat. The controls on the synthbox change the display and the output volume, and the controls on the Crackers controller set the levels of the four sound tracks, adjust the sounds made by the keyboard, and control the amount of reverb.

The synthbox is controlled by Pure Data patches which generate the sounds and send commands to create synchronised sound and music displays. The NeoPixel display and rotary encoders are driven by a CircuitPython program running on a Raspberry Pi Pico. This communicates with the Raspberry Pi computer

Figure 1 ■

The synthbox is on the left. The colour of the box is the closest the author could get to 'chocolate box purple'

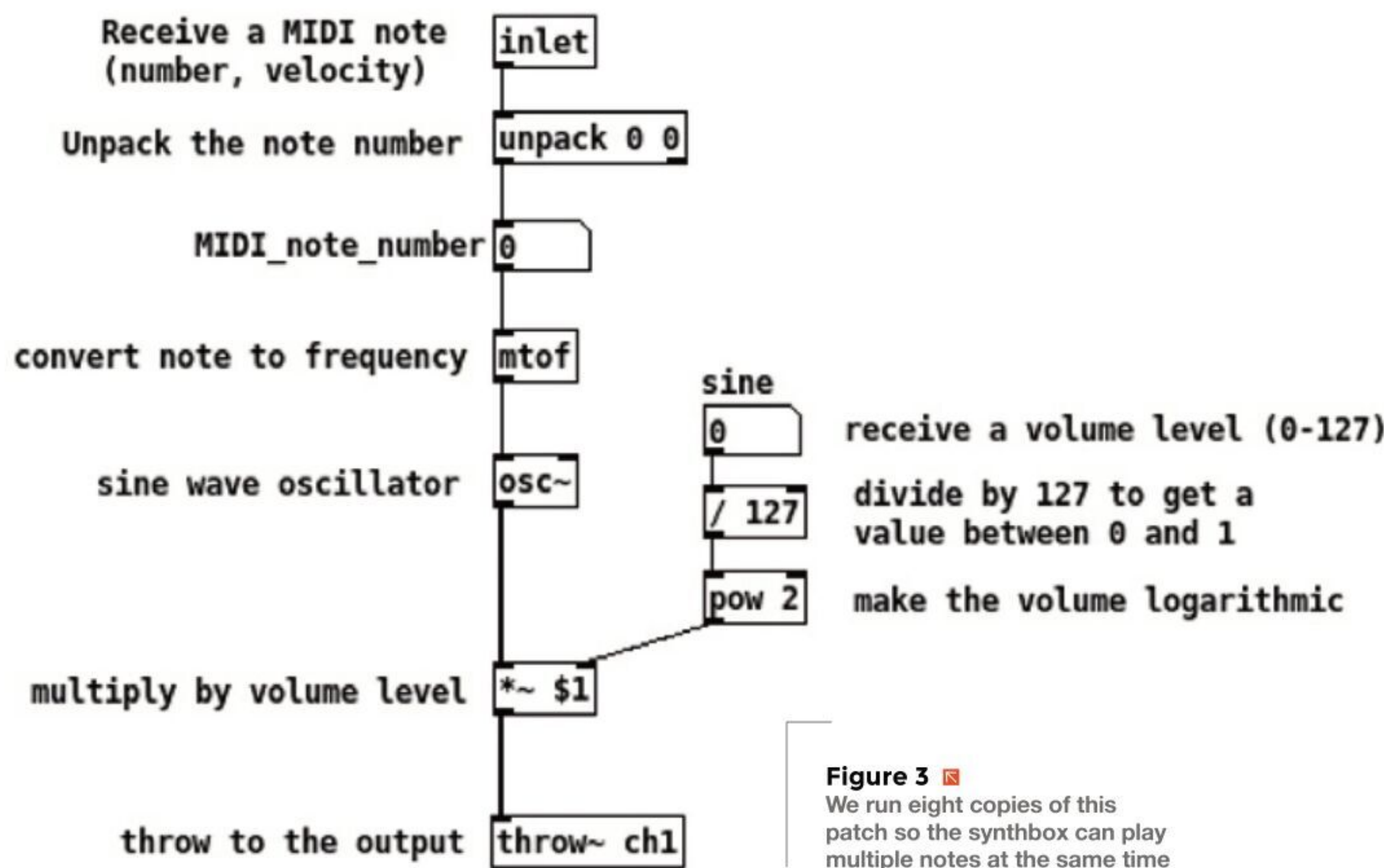

Figure 3 We run eight copies of this patch so the synthbox can play multiple notes at the same time

over a serial connection. It means that the Raspberry Pi can focus on making sounds while the Pico provides display animation and reads the rotary encoders. You can add more sound and audio processing by editing the Pure Data patches.

You can use the synthbox as a portable Raspberry Pi with amplified speakers. You can create your own programs to drive the screen and read the rotary encoders. There is no video connection to the synthbox, but you can use a remote desktop connection if you want to work with the Raspberry Pi desktop. You can find everything you need to build the project here: hsmag.cc/ChocSynthBox.

CONTROLLING THE SYNTHBOX

The synthbox is fitted with a pair of rotary controllers and an 8x8 matrix display. The matrix provides a mini light show as the sounds are played. It also displays setting values when the controllers are adjusted.

Figure 2 The control display remains for a couple of seconds after a control is adjusted, which is how this picture was taken

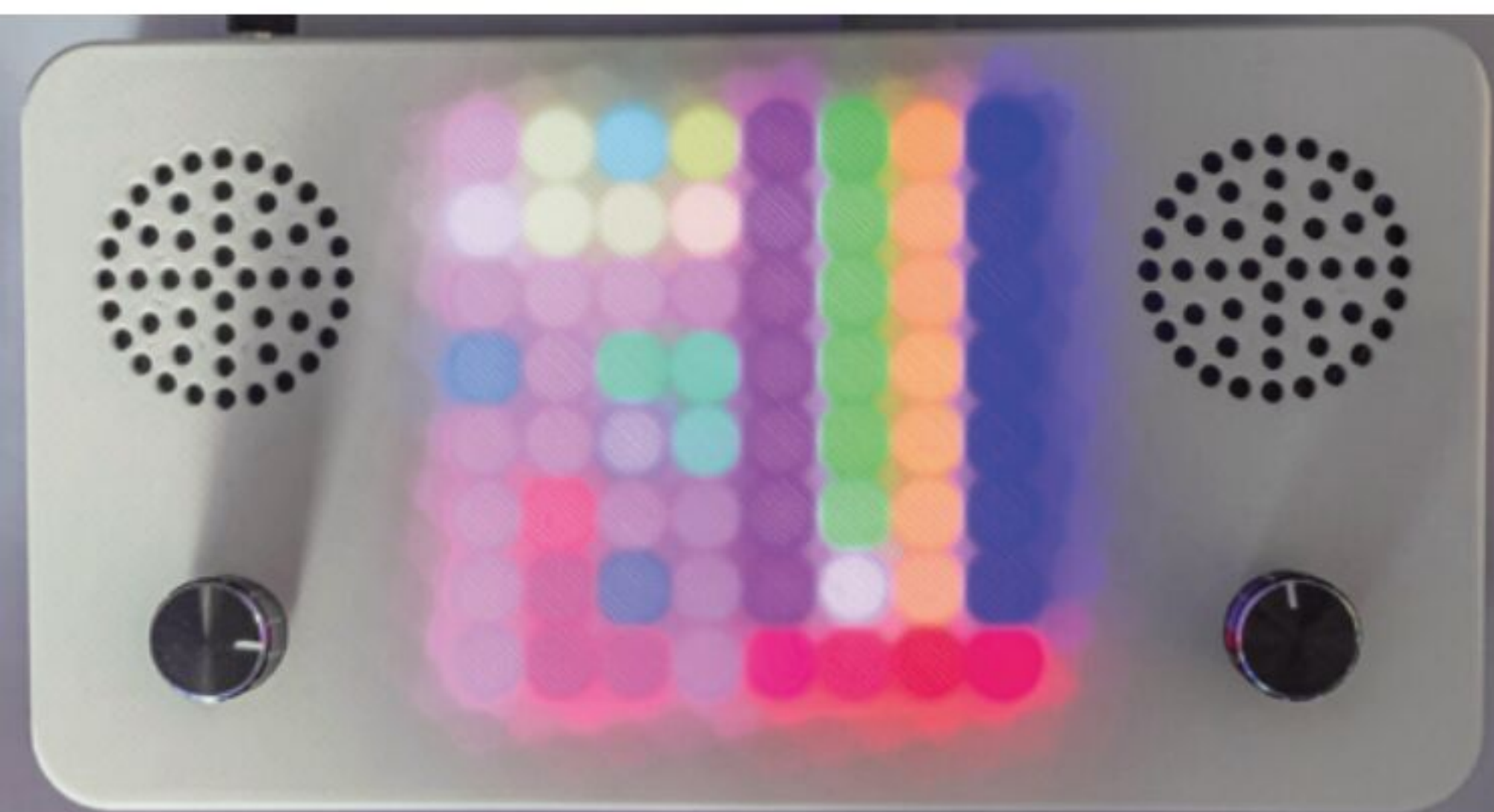

Each controller manages four values. When the controller is turned, the level display for that controller appears on the side of the display. The level being controlled is indicated by a white dot. You can see the dot towards the bottom of the sixth column of the matrix in **Figure 2**. Pressing the controller in moves the dot to the next channel to be controlled.

The controllers and the display are managed by the Pico. Each time a controller is changed, a message is

“ The controllers are used to adjust the volume of the sound output and adjust the ‘screen saver’ display ”

sent to the Raspberry Pi which is picked up by the Pure Data program making the sounds. The controllers are used to adjust the volume of the sound output and adjust the ‘screen saver’ display.

POWERED BY PURE DATA

Pure Data was created by Miller Puckette, a distinguished Professor of Music at the University of California San Diego. The program that provides the Pure Data environment and runtime system is freely available for all major platforms. You can find out more at puredata.info. All the synthbox sounds are created by a Pure Data patch running on the Raspberry Pi. The sounds are a mix of digital waveforms and samples.

A Pure Data program passes sound and data values between processing objects. The connections between the components are called ‘patch cords’ and a Pure Data program is called a ‘patch’ or a ‘canvas’. →

YOU’LL NEED

- ◆ **Raspberry Pi**
The software works with any Raspberry Pi from the Zero upwards - a Raspberry Pi 4 is best
- ◆ **Raspberry Pi sound card and amplifier**
I used the Waveshare WM8960 but you can also use the Adafruit I2S 3W stereo Speaker Bonnet or Voice Bonnet
- ◆ **Pixel panel**
The prototype uses an Adafruit NeoPixel NeoMatrix 8 x 8 - 64 RGB LED Pixel Matrix. This board is 71 mm x 71 mm in size. You can get WS2812 8 x 8 pixel matrices which are smaller (65 mm square). There are 3D-printable case designs for each size
- ◆ **Two rotary encoders**
(search for ‘KY 040 encoder’)
- ◆ **A small speaker**
(You can get a very nice one from Pimoroni: hsmag.cc/MiniSpeaker3W. You can get the connectors you need to power the Raspberry Pi and the Pico by buying a USB-C Power Splitter for Raspberry Pi Touchscreen Display
- ◆ **Female 5.5 mm x 2.1 mm power socket**
- ◆ **A power supply capable of supplying 5 volts at least 4 amps with a 5.5 mm x 2.1 mm plug**
- ◆ **Connecting wire**
(search for ‘30 AWG wire wrap’) which needs a wire wrap tool (search for ‘wire wrap tool’)
- ◆ **Screws**
Some screws sized M2 4 mm in length to fix things to the case (search for ‘laptop screws’) →

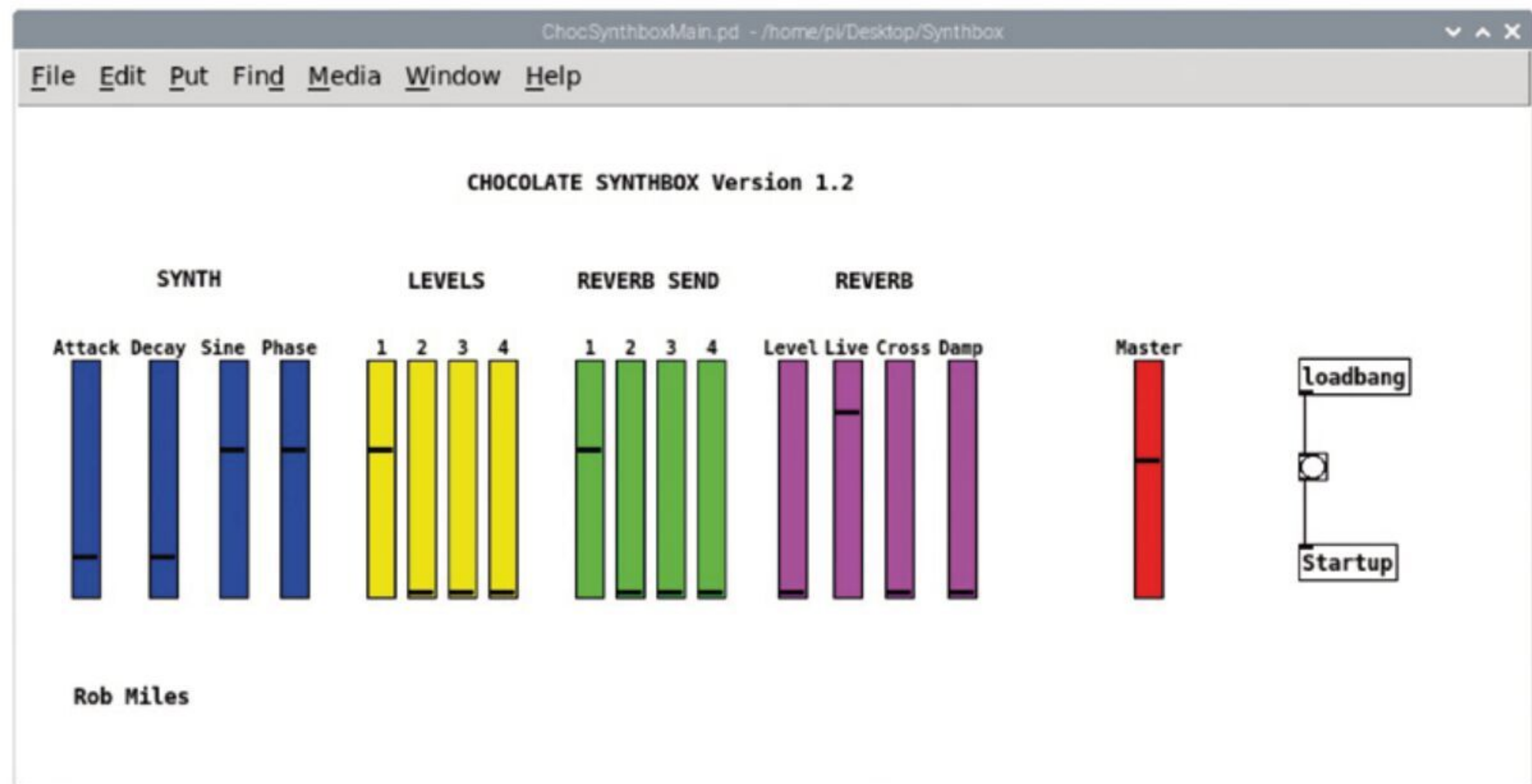

Figure 3 shows the patch that produces the sine wave component of the sound output. We can see what it does by following the flow of signals through the patch. The **inlet** object at the top receives a message containing the MIDI note number (which identifies the note to be played) and the volume of the note. The synthbox controls the volume of each note with a volume control, so the first thing the patch does is use an **unpack** object to split off the MIDI note number. The note number is fed into a **mtof** box which converts the MIDI note number into an audio frequency. This frequency is then fed into an **osc~** box which produces a cosine wave at the specified frequency. The '~' on the end of the name

indicates that an object works with a sound signal. It's a bit hard to see on **Figure 3**, but the output from the **osc~** box is drawn as a thicker line to show that this is a sound signal path.

On the right of the patch, you can see another flow through the patch that controls the volume of the output. The flow starts with a number object that is sent a value from the patch that receives commands from a MIDI controller. This value is the volume level of the **sine** value we want. Every time the user adjusts the volume, a message is sent to here. It's a MIDI controller message, which is a value between 0 and 127. This value is divided by 127 to make a number level between 0 and 1. We are going to multiply the level of the oscillator output by this value so that the level of the sine output changes from silent to full volume.

Figure 4 The coloured controls match those on a crackers controller

Figure 5 The brown and black wires between the Pico and the Raspberry Pi are for the serial connection

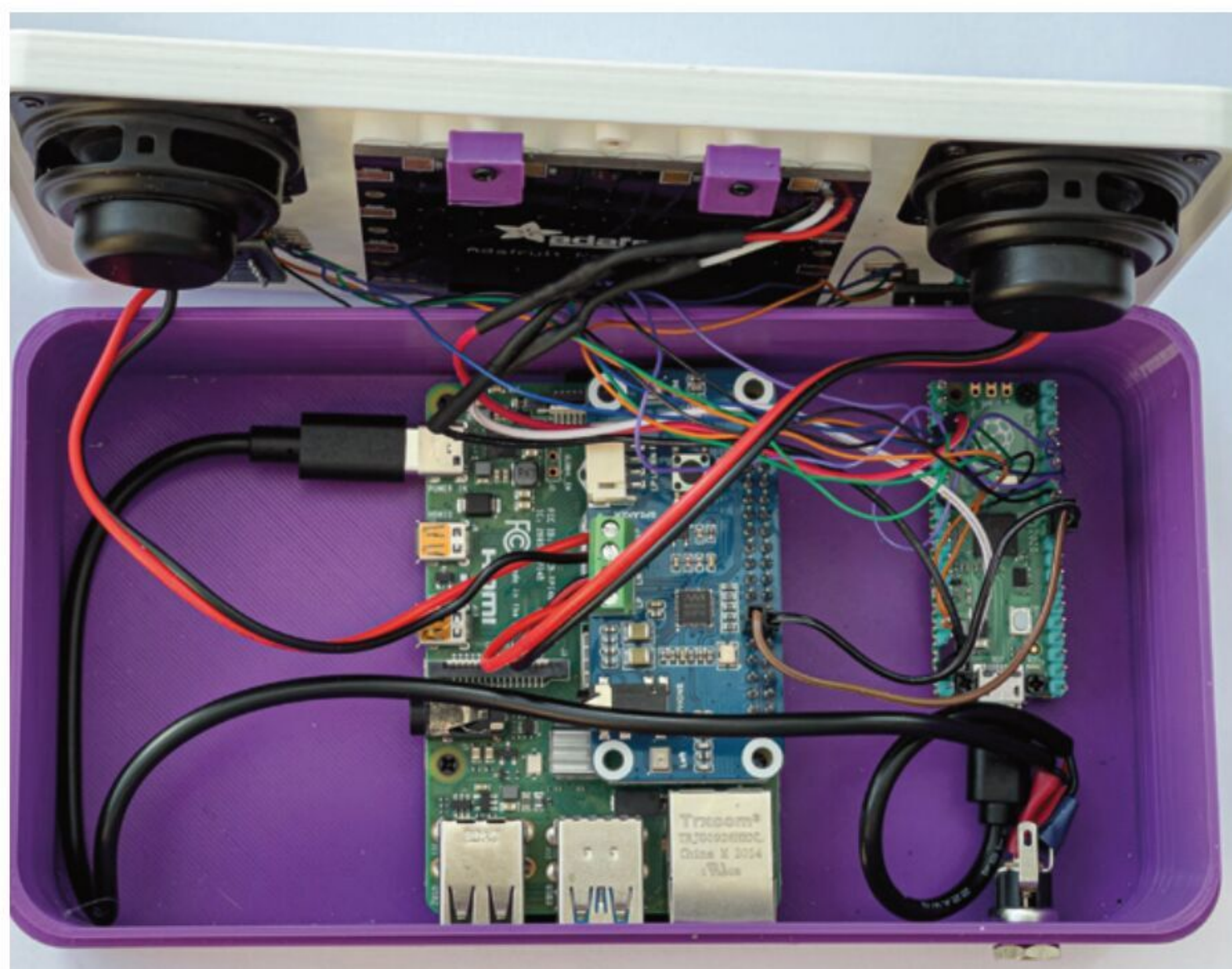

// The Pico needs a way to tell the Raspberry Pi when the user turns the rotary encoders //

When we adjust a volume control, we expect the level change to be 'logarithmic'. This has to do with the way that our ears respond to sounds from near and far objects. We can get a logarithmic effect by squaring the volume level using a **pow** object. The result is a value which is then fed into a multiply (***~**) object which generates a sine signal which is 'thrown' to **ch1**. Note that the multiplication operation is working on a sound signal, which is what the '~' on the end of the operation name

means. The **ch1** location brings combined multiple incoming signals to generate the final sound that is sent to the speaker.

Hopefully the above example will have given you a flavour of Pure Data development. It is a very powerful place to work. You can easily route signals between patches and then send them on. You can also add objects that provide a user interface.

Figure 4 shows the main patch that controls the synthbox. It contains a set of sliders to control the synthesizer. On the far right is a **loadbang** object that fires an event when the patch is first loaded. This event is sent to the **Startup** patch which loads all the other patches. The Raspberry Pi in the synthbox automatically starts this Pure Data patch when it starts running. There are instructions on how to set this up in the repository for this project.

OPEN THE CHOCOLATE BOX

Figure 5 shows how the Raspberry Pi and the Pico are fitted inside the case. The Raspberry Pi is on the left and the Pico is on the right. There is a Waveshare WM8960 sound board fitted on top of the Raspberry Pi which drives the speakers. This board also has a microphone so you can record audio with the synthbox, but the present version of the software doesn't do this. The rotary encoders and the display are connected to the Pico.

TWO BRAINS ARE BETTER THAN ONE

The synthbox contains two computers, as you can see in the circuit diagram in **Figure 6**. The Raspberry Pi runs the Pure Data sound output program. The Raspberry Pi Pico runs a CircuitPython program which drives the pixel panel and receives input from two rotary encoders. The Raspberry Pi and the Pico communicate over a serial connection. The Raspberry Pi sends commands to the Pico to control what appears on the screen. The Pico sends messages to the Raspberry Pi when the user interacts with the two rotary encoders. You might think that adding a second device would make it more difficult to create the software that controls the synthbox, but it actually makes it much easier. The animations on the pixel matrix are updated 50 times a second. It would be very hard to maintain this frame rate and generate smooth-sounding audio.

SENDING MESSAGES FROM THE PICO TO THE RASPBERRY PI

The Pico needs a way to tell the Raspberry Pi when the user turns the rotary encoders. Pure Data has a built-in protocol for sending and receiving streams of

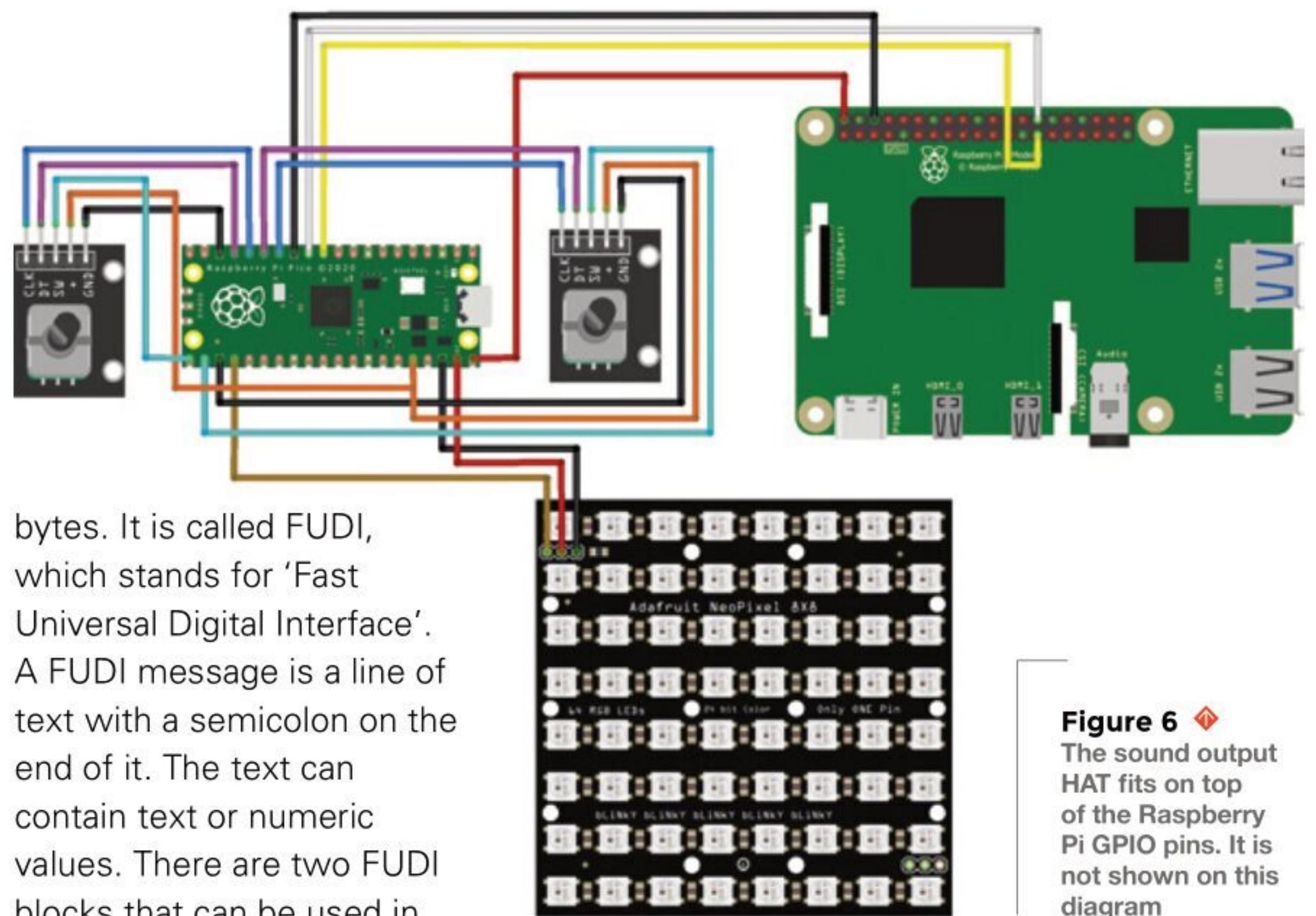

Figure 6 ♦ The sound output HAT fits on top of the Raspberry Pi GPIO pins. It is not shown on this diagram

bytes. It is called FUDI, which stands for 'Fast Universal Digital Interface'. A FUDI message is a line of text with a semicolon on the end of it. The text can contain text or numeric values. There are two FUDI blocks that can be used in Pure Data patches. The

fudiformat block takes a list of Pure Data values and converts it into a message to be sent as a sequence of bytes. We can use this to create messages we can send from the Raspberry Pi to the Pico. The **fudiparse** block takes a buffer of bytes and converts it into a list of Pure Data values. This block is used in the Raspberry Pi to decode messages from the Pico.

The Pico sends FUDI-formatted messages when the user turns the encoders on the synthbox. For →

PIXEL POWER

The synthbox is fitted with a pixel matrix that uses WS2812 'NeoPixels' to generate a display as the music is played. These are amazing devices, but they can have problems with their control signal voltage level. The control signal tells each pixel how much red, green, and blue to display using a series of data pulses. You might think that these pulses are normal logic levels, perhaps 3.3 volts for 1 and 0 volts for 0. However, this is not how they work. Instead, a signal of more than 60% of the supply voltage is regarded as 1. If you are powering the pixels from a 5-volt supply, this means that the control signal must get above 3 volts (3 is 60% of 5) to register 1. The Pico uses 3.3-volt logic, so in theory it should work with .3 volts to spare. However, if the power supply voltage goes up a bit, or the pixel is a bit picky, you might find that your lights don't work.

In the author's experience, most pixels will work with 3.3-volt logic level – the one exception seems to be the large Adafruit matrix used in this project. This only worked if powered by the 3.3-volt supply from the Pico in the prototype. This is not a perfect solution; it limits the maximum brightness of the LEDs, but it does work. A better solution would be to use a logic level converter to lift the 3.3-volt signal from the Pico to 5 volts, and then use a dedicated supply for the pixels. This would allow the use of much larger panels, something the software in the Pico can be adjusted to handle.

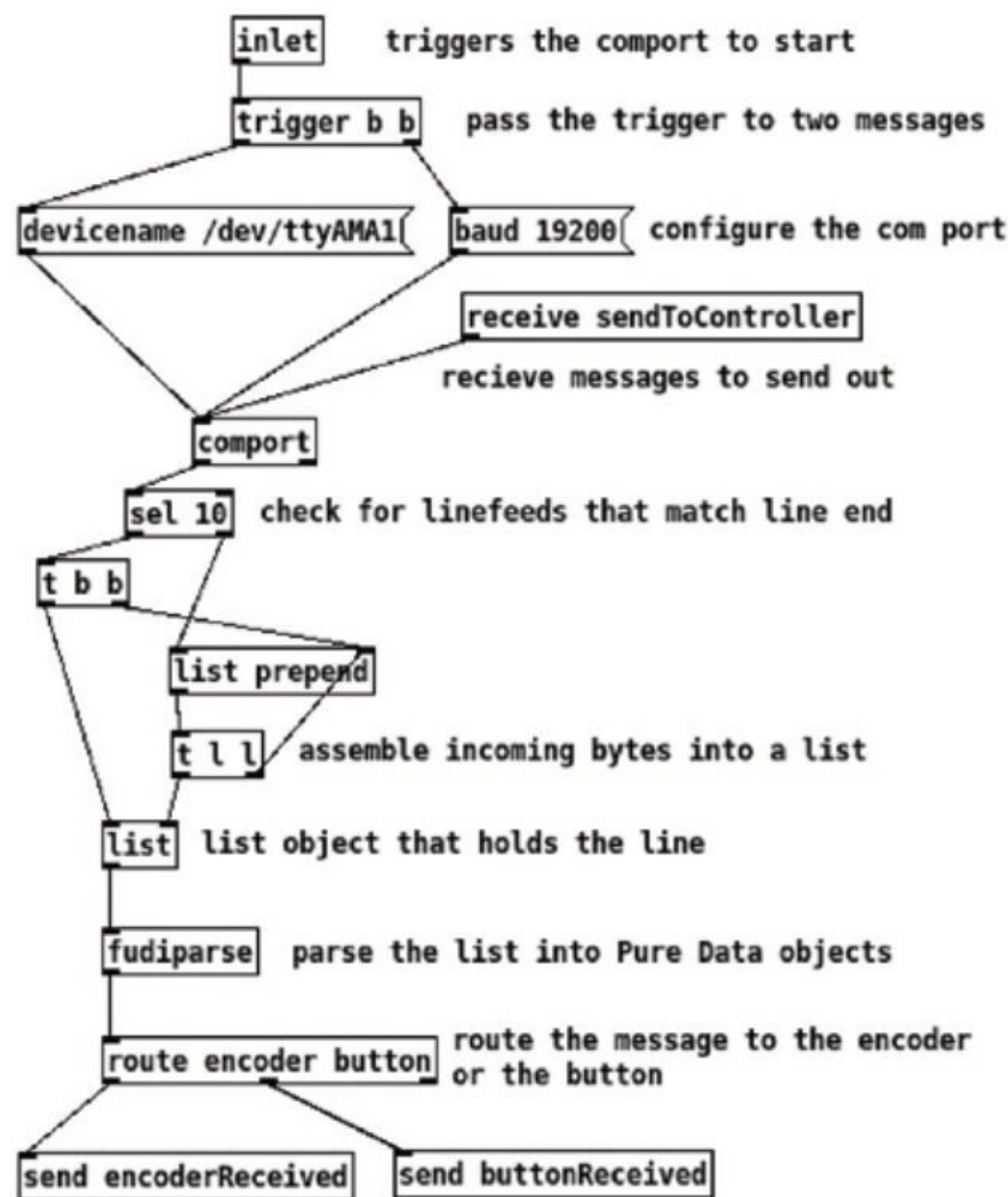

Figure 7 You can change the settings for the comport to use a different serial port or data rate

example, if encoder 5 is moved to value 97, the Pure Data patch receives a message like this:

```
encoder 97 5;
```

This message can be decoded in Pure Data using a **fudiparse** block, but first, the incoming characters from the Pico need to be assembled into a list of values for **fudiparse** to work on.

Figure 7 shows the patch that uses the comport to receive the encoder values. The **comport** object at the top provides a connection to a serial port on the Raspberry Pi. The output at the bottom of the **comport** object sends out characters as they are received. The line feed character (10) is used to mark the end of an incoming line of text. A message that starts with the word 'encoder' is sent to the **encoderReceived** destination at the bottom which routes the value to the appropriate patch.

SENDING MESSAGES FROM THE RASPBERRY PI TO THE PICO

The Raspberry Pi sends commands to the Pico to draw things on the LED matrix. Let's find out how the communication works by looking at how Pure Data clears the pixel matrix to a random colour. The patch shown in **Figure 8** is called **doRandomFill** and fills the entire screen with a random colour. The random colour is created by using three **random** objects, one

for red, one for green, and one for blue. If you follow the flow of execution down from the input which triggers a new **random** block, you can see that the blocks are all triggered to generate a new value. Each **random** object generates a value in the range 0 to 255 that represents the amount of that primary colour to be used in the fill. The three values are then assembled into a message that contains a sequence of values that will tell the Pico what to do. The first byte of a message is the command number. A command is followed by a sequence of values that tell that message what to do. Command number 0 is 'draw a coloured block'. The values that follow the command number are the options for the command. When the Pico receives this block, it looks at the first byte, discovers that it is a 0 (draw a block), and passes the rest of the message off to be processed. The message format is defined in the Python program in the Pico as follows:

```
self.defaults = (
    (Types.NUMBER_INPUT, 0),      # 0 red
    (Types.NUMBER_INPUT, 0),      # 1 green
    (Types.NUMBER_INPUT, 0),      # 2 blue
    (Types.NUMBER_INPUT, 5),      # 3 steps
    (Types.NUMBER_INPUT, 0),      # 4 x
    (Types.NUMBER_INPUT, 0),      # 5 y
    (Types.NUMBER_INPUT, self.width), # 6 width
    (Types.NUMBER_INPUT, self.height) # 7 height
)
```

This is how the Pico makes sense of the incoming sequence of values. The **self.defaults** variable defines the eight items in the command. Each item is defined by two values: the type of the item (in this case the items are all numbers) and the default value (the value to be provided if this item is not present). The default value for red is 0, the default value for green is 0, and so on. The default value for the number of steps for the colour change is defined as 5, the default position for the block is the top left-hand corner (x and y are 0), and default values for the width and height are the size of the matrix.

Code in the Pico works through the received values and assembles the result values. If the command does not have some values on the end, the Pico uses the default values for the rest of the items. So, an 'empty' set of values would clear the entire screen black in five steps because it would use all the default values. If you look at the command assembled in **Figure 8**, you can see that the location of the block and the width and height values are not sent, so the block is drawn over the whole screen.

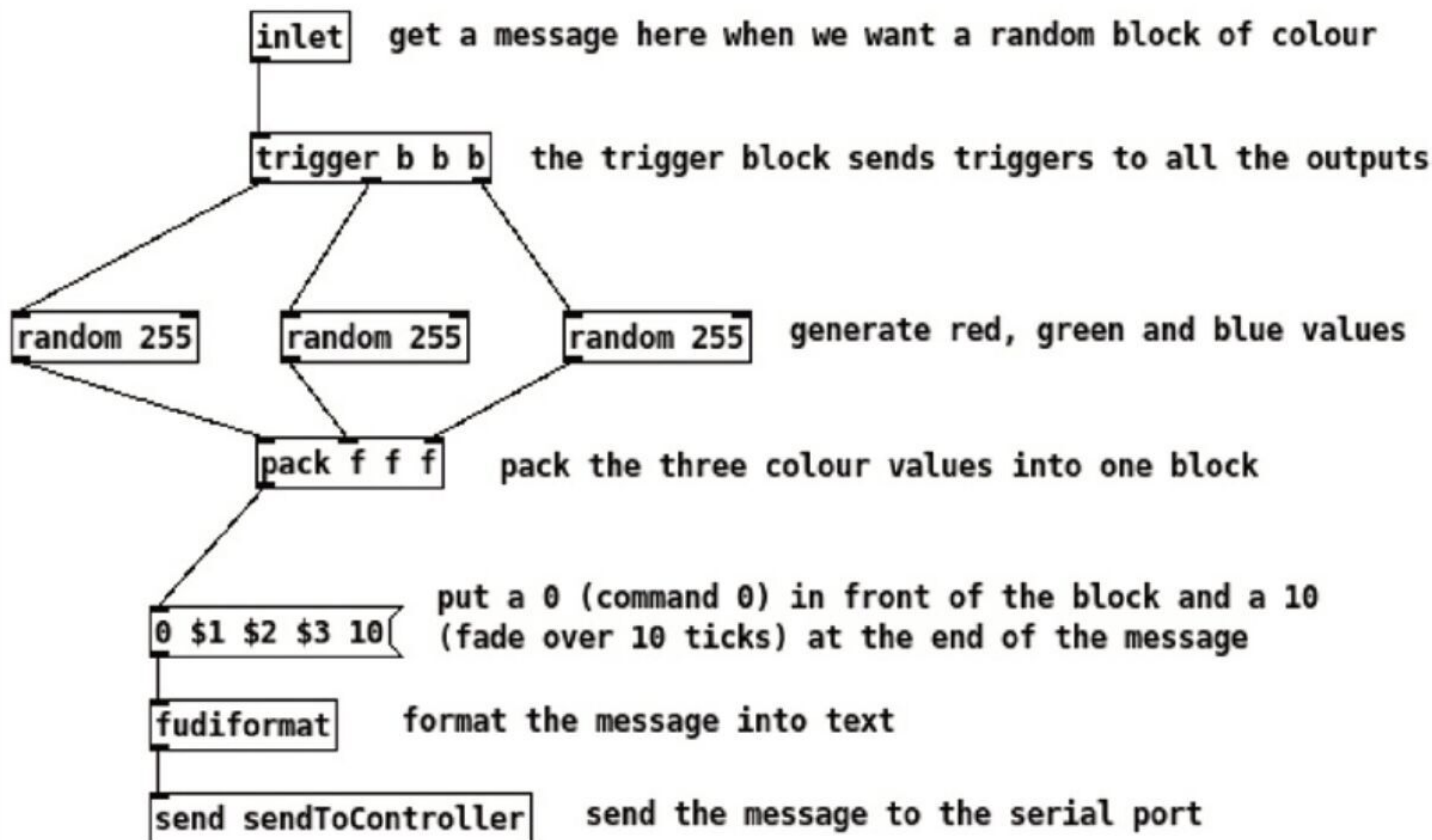

Figure 8 You could change the balance of the colours by changing the range of the random numbers

```
self.defaults = (
  (Types.NUMBER_INPUT, 0),      # 0 red
  (Types.NUMBER_INPUT, 0),      # 1 green
  (Types.NUMBER_INPUT, 0),      # 2 blue
  (Types.NUMBER_INPUT, 5),      # 3 steps
  (Types.NUMBER_INPUT, 0),      # 4 x
  (Types.NUMBER_INPUT, 0),      # 5 y
  (Types.TEXT_INPUT, "hello world"), # 6 text
  (Types.NUMBER_INPUT, 0)      # 7 repeat
)
scroll
```

This design makes it easy for us to create and decode new commands. Above, you can see the default values for command 2, which scrolls a text message across the matrix. The default text for a message is 'hello world'.

GOING FURTHER

The synthbox was great fun to build, and the author learned a lot about connecting an embedded device to a Pure Data application. The finished result makes all kinds of interesting things possible. We could use real-world values to control sound synthesis by connecting the Pico to sensors and using them to control the sound output. We could also make music that has mechanical outputs. You could attach some servos to a Pico, add some extra commands alongside the existing pixel ones, and make a piece of orchestral music that conducts itself. □

POWERING UP

The back of the synthbox is where you plug everything in. The USB and network connections of the Raspberry Pi can be accessed directly. The power connection accepts a 5-volt supply via a standard barrel connector. Both processors in the synthbox are connected to this. There are GPIO pins on both the Pico and the Raspberry Pi devices which can accept a 5-volt supply. The author was concerned about supplying power via these pins, as their connections bypass the power protection circuits on the devices. It was decided to make up a cable so that the USB connectors could be used for the power input. The best way to obtain the parts to make this cable is with a USB-C Power Splitter for Raspberry Pi Touchscreen Display cable. You can plug a Raspberry Pi power supply directly into this and then connect the Raspberry Pi and Pico, or you can cut the cables off and solder them onto the power socket, as in **Figure 5**. The synthbox works with the Raspberry Pi 3-amp power supply, but has problems with some other 3A supplies because the sound amplifier can draw quite a bit of current when played loud. The author purchased a 4A supply and that works fine.



Left There is a slot in the front of the box to access Raspberry Pi's microSD card

Get creative with double hinges

Bend reality with a couple of historic curiosities, and a slightly more recent mathematical contrivance



Mike Bedford

Despite loving all things digital, Mike admits to being a bit of a Luddite, vinyl records and all.



ur first mechanism is a magic wallet, and your author was first introduced to one more years ago than he'd like to admit, when his grandad made one for him.

It's the simplest of our three projects but, hopefully, what it lacks in complexity, it more than makes up for in being downright fascinating. You could make a magic wallet for banknotes, aka bills, or you might choose to make one for business cards. Although that decision will affect how large it is, you'll be following exactly the same instructions.

Start by cutting out four rectangles – either from cardboard or, for a more durable result, from thin plastic sheet of the type sold for model-making – a bit larger on all four sides than a banknote or a business card. Now, tape four lengths of ribbon – which should, ideally, be a different colour from

the card – to two of the rectangles of card, as shown in **Figure 1** below, which are views of the cards which are flipped horizontally. At this point you'll have a working magic wallet, but it won't look too good because the taped ends of the ribbons on one side of each of the cards will be clearly visible. This brings us to the other two rectangles which, to complete the wallet, should be glued over the sides of the cards with the taped ends of ribbon, and left to dry.

Now let's see the magic wallet in action. With the wallet open, so that you see two parallel ribbons at one side and two crossed ribbons at the other, place a banknote or business card inside the wallet so that it's sitting on top of either the parallel or crossed ribbons. Close the wallet. You'll now find that you can open it from either side, but open it from the opposite side from the one you've just closed, and you'll discover that the banknote or business card is

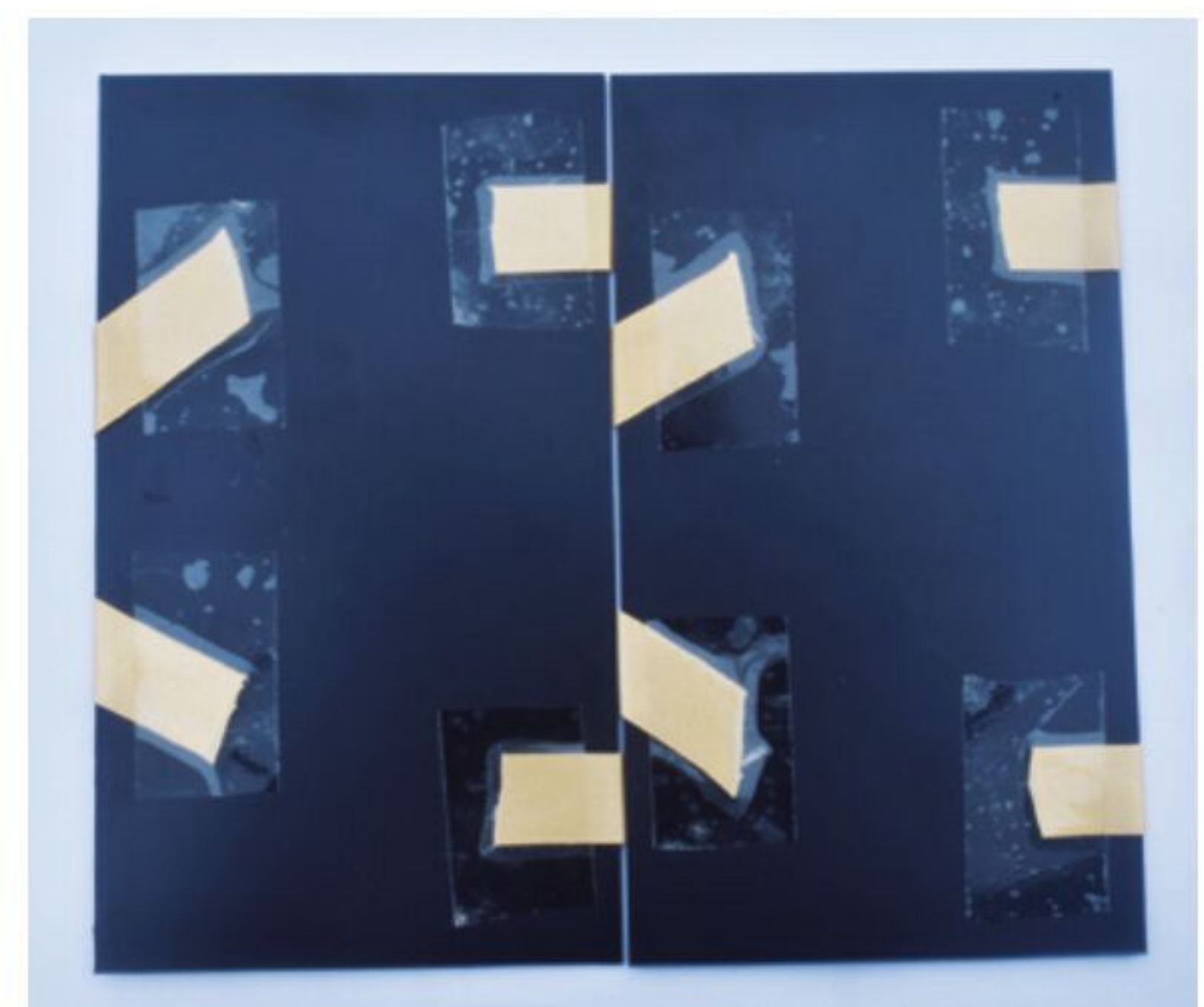
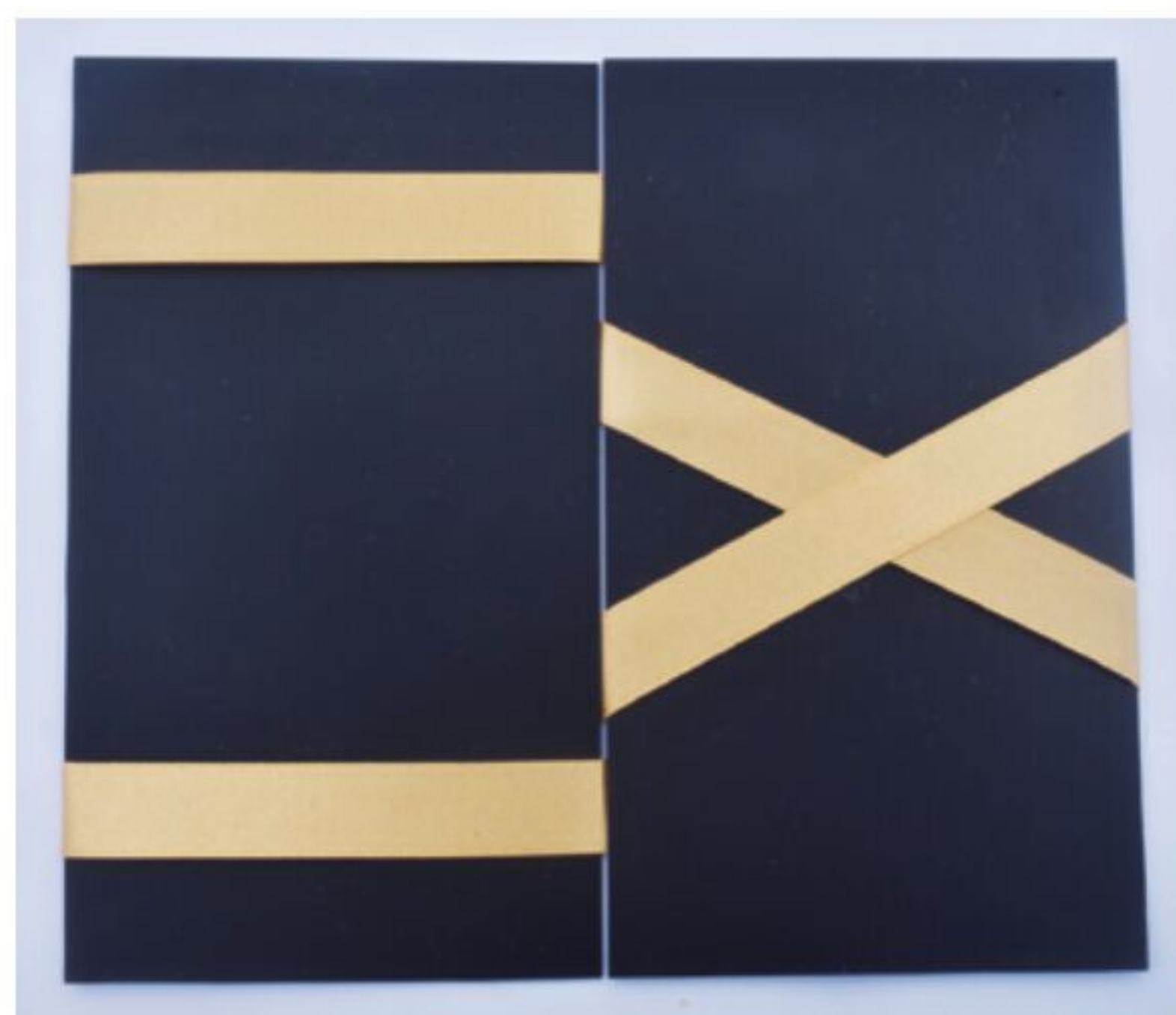



Figure 1 ♦ A magic wallet can't be much easier to make. Here, we see it from both sides before the extra pieces of board were glued on to hide the untidy ends of the ribbons



Above & Below  If you close and open the wallet from a different side, its contents transfer from under the parallel ribbons to under the crossed ribbons. Now that's magic!

now held in place because it's under either the parallel or crossed ribbons. Close it, and open it again from the opposite side, and you'll find that the contents will have transferred either from under the crossed to the parallel ribbon or vice versa. Magic? Not exactly, despite its name, but we think it's quite

// Magic? Not exactly, despite its name, but we think it's quite cool **//**

cool. Even so, this is a curiosity, not a genuinely useful wallet, so we don't recommend you entrust a £50 note or a \$100 bill to the wallet and expect it to remain securely in place.

JACOB'S LADDER

To start, saw up eight squares of wood about 50 mm square and 10 mm thick, although the size isn't critical. Sand the edges to make sure they're not rough. Now, using a short nail or tack with a decent-sized head, attach a length of ribbon to the middle of an edge of one of the wooden squares, and two pieces of ribbon to the opposite edge, as shown in **Figure 2** overleaf. Each of those lengths of ribbon should be at least 600–700 mm long, and it'll look good if the single ribbon is a different colour from the pair of ribbons. Don't attempt to nail the ribbon into the end grain because that'll increase the likelihood of



the wood splitting, but drive the nails perpendicular to the grain.

Next, with that first square flat on a work surface – as it is in **Figure 2** – pass the ribbons across the top of the square in different directions, as shown in **Figure 3**, overleaf. As you can see in that photo, there should be a reasonable gap between each of the three ribbons. Now, put a couple of cardboard squares on top of the first wooden square, and add a second wooden square on top of the first, before passing the three tapes over that square in the opposite direction to the first square. You can see →



Figures 2 & 3 ♦ Making a Jacob's ladder involves just some simple wood working, as you can see here

the situation after adding the second wooden square in **Figure 4**. The cardboard squares are only used to space the wooden squares adequately and will be removed afterwards. Continue in this way until all eight wooden squares are piled on top of each other with the two ribbons and the single ribbon threaded back and forth between them.

Now turn the stack of wooden squares, complete with their cardboard spacers, onto its side with the edges that the ribbons pass over uppermost. Secure the ribbons to all the wooden squares other than the first – because you'll already have nailed the ribbon or ribbons to that square – again using nails. Turn the stack over and do the same on the other side, before trimming off the excess length from the ends of the ribbons. Your construction will now look like **Figure 5**.

Your Jacob's ladder is now finished except for removing the cardboard spacers, and you'll find it easier to do that if you first open it out, so it looks like an interconnected string of eight wooden squares. So, with the spacers removed, it's time to try it out. Hold it from one of the end squares, with

your thumb and a finger on opposite edges, and the face with no ribbons on it closest to your palm, while allowing all the other squares to hang below – see **Figure 6**. Admittedly that's not how it appears in the photo – the face with the ribbons is closest to the palm – but that's because we'd already moved on to

the next step. Tilt the top square forward until it's almost parallel to the second block. When you've tilted it far enough – to the tipping point, quite literally – you'll find that the square below it will cascade down to the

When you've tilted it far enough, you'll find that the square below it will cascade down to the bottom

bottom, flipping from side to side as it goes. Or at least, that's how it appears. It's actually an optical illusion, and what really happens is that each square in turn simply flips over. And the reference to Jacob? If you open your *Bible* to *Genesis 28:10–19*, you can read the following narrative about Jacob's vision, "And he dreamed that there was a ladder set up on the earth, and the top of it reached to heaven; and behold, the angels of God were ascending and descending on it".

TETRAFLEXAGONS

Back in HackSpace #51, we showed you how to make hexaflexagons. They're six-sided figures, made from paper or card, and they don't just have two sides as ordinary hexagons do. Instead, they have additional faces that are revealed by manipulating the hexaflexagon in a particular way, a process called flexing. But hexaflexagons aren't the only class of flexagon, and here we're going to see how to make an alternative – a mathematical curiosity called a tri-tetraflexagon. The 'tri' bit means it has three faces, two visible and one hidden at any time; the 'tetra' means it has four sides – in other words, it's





square; and the 'flexagon' bit means it flexes. So, here's how to make one.

Draw or print the pattern shown in **Figure 7**, overleaf, onto thin card. Don't use ordinary printer paper because it'll warp and wrinkle when you subsequently paste it. 236 gsm card (actually, glossy photo paper) worked well, but be sure not to exceed your printer's capacity. You'll find similar templates to the one shown here online for printing, which will make it easier, although if you use a template that's numbered differently, our folding instructions won't be totally applicable. Cut out the two parts and →

Figure 4 ♦
As each block is added, the ribbons get wrapped around

Figure 6 ♦
The completed Jacob's ladder in action

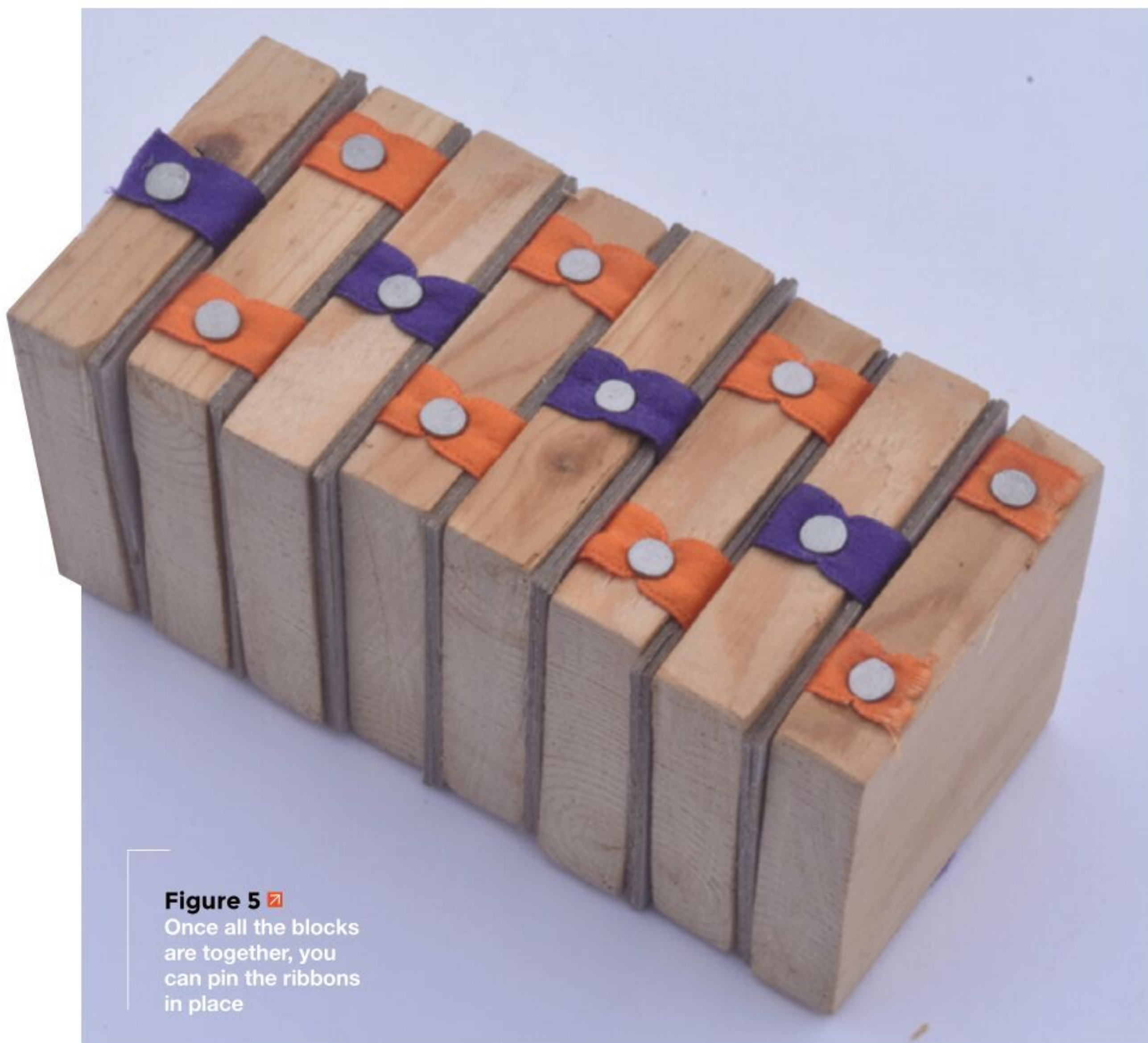

Figure 5 ▣
Once all the blocks are together, you can pin the ribbons in place

Get creative with double hinges

TUTORIAL

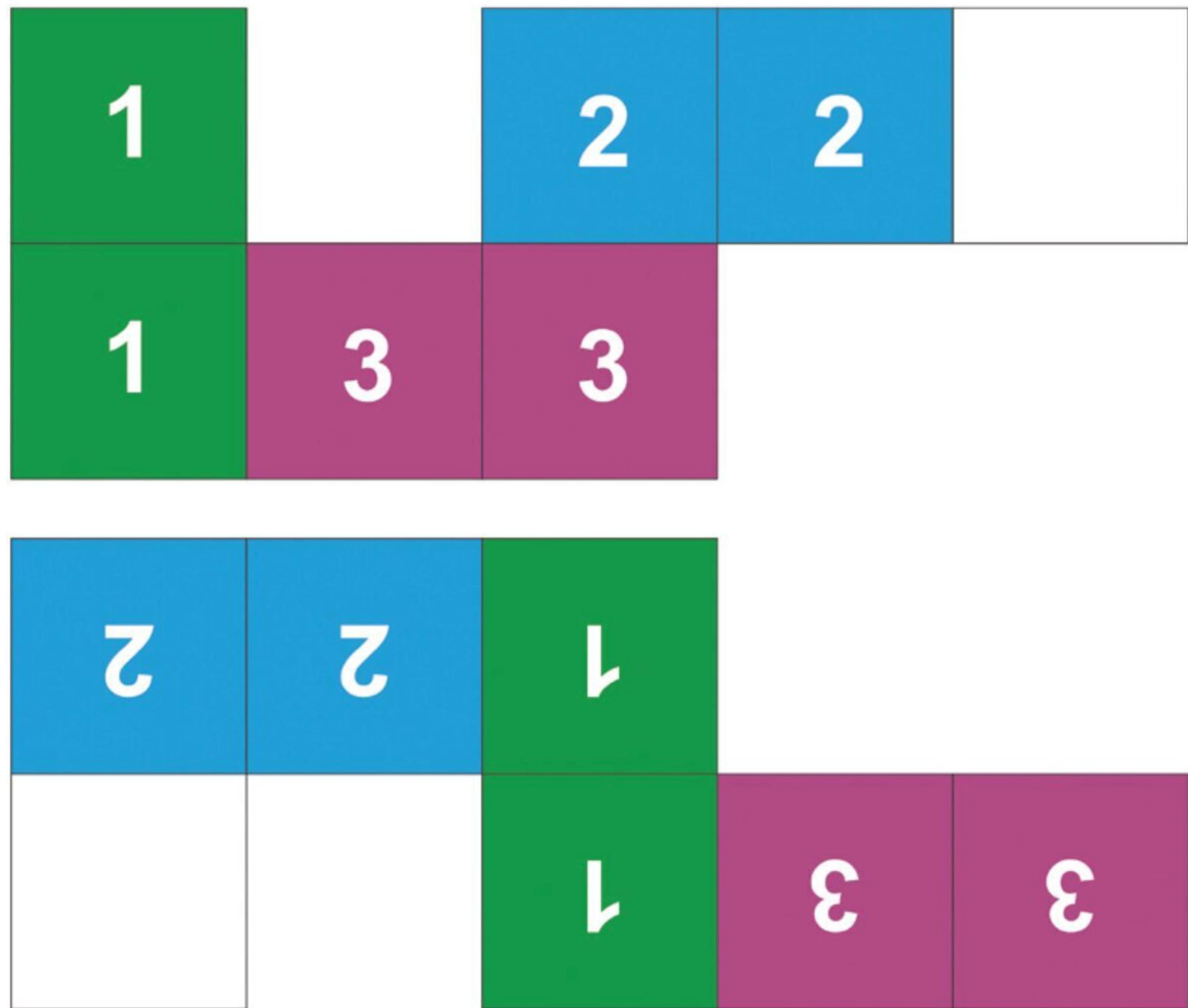

Figure 7

To make a tri-tetraflexagon, draw or print this pattern, cut out the two parts and paste them back to back, and then fold and glue it as described

paste them back-to-back. When the glue has fully dried, carefully score along both sides of all the dividing lines, and bend them back and forth.

Next, make sure the side with the squares numbered '3', '3', and '1', in that order, are facing

you in the top-left corner. Fold the two squares numbered '3' backwards by folding along the line between the second square numbered '3' and the square numbered '1'. Now, without turning it over, bend forwards along the line between the two squares numbered '2'. Finally, glue together the two unnumbered squares, which you'll find behind the top-right square which will be numbered '1'. Make sure the glue has dried completely before trying out

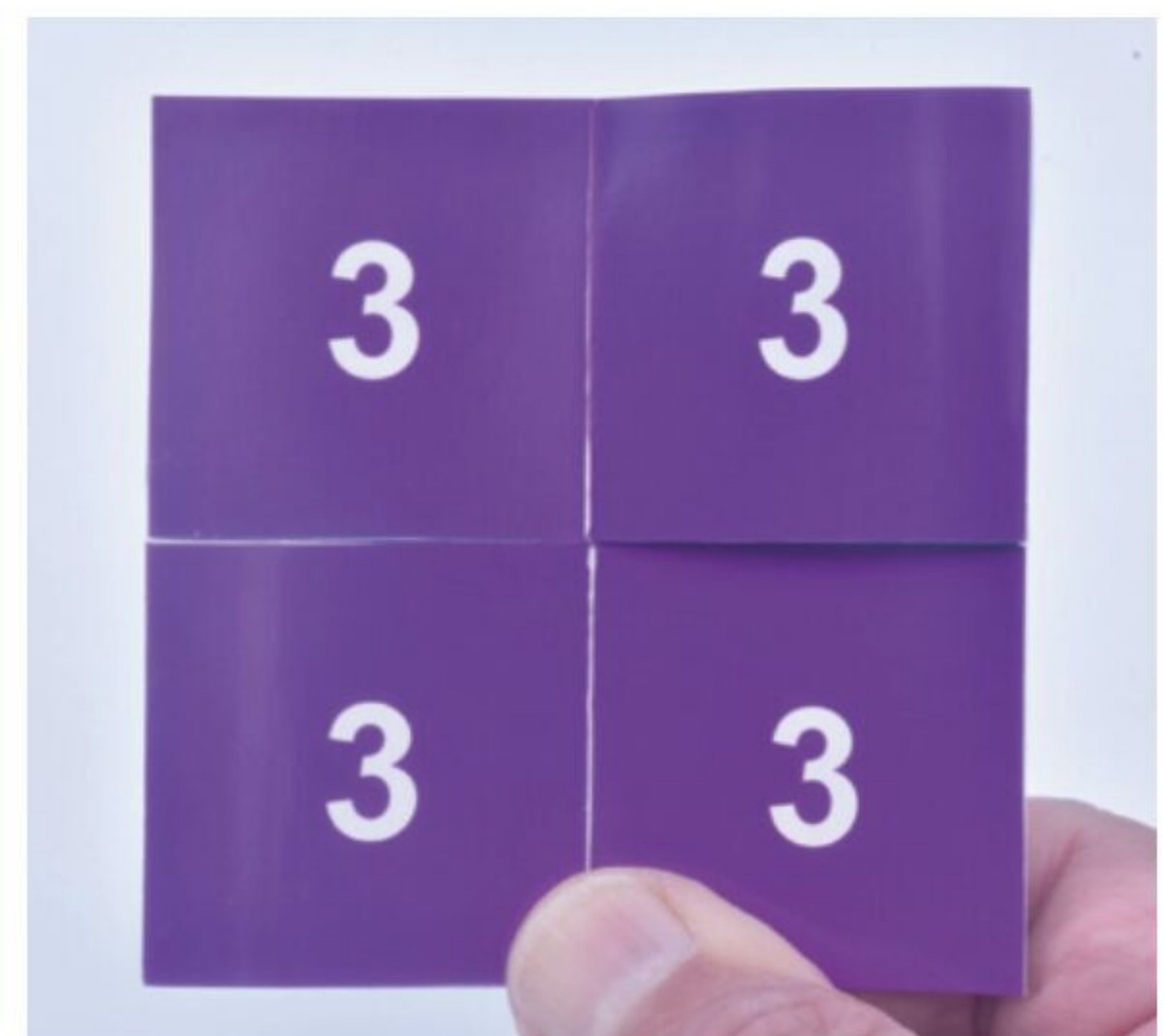
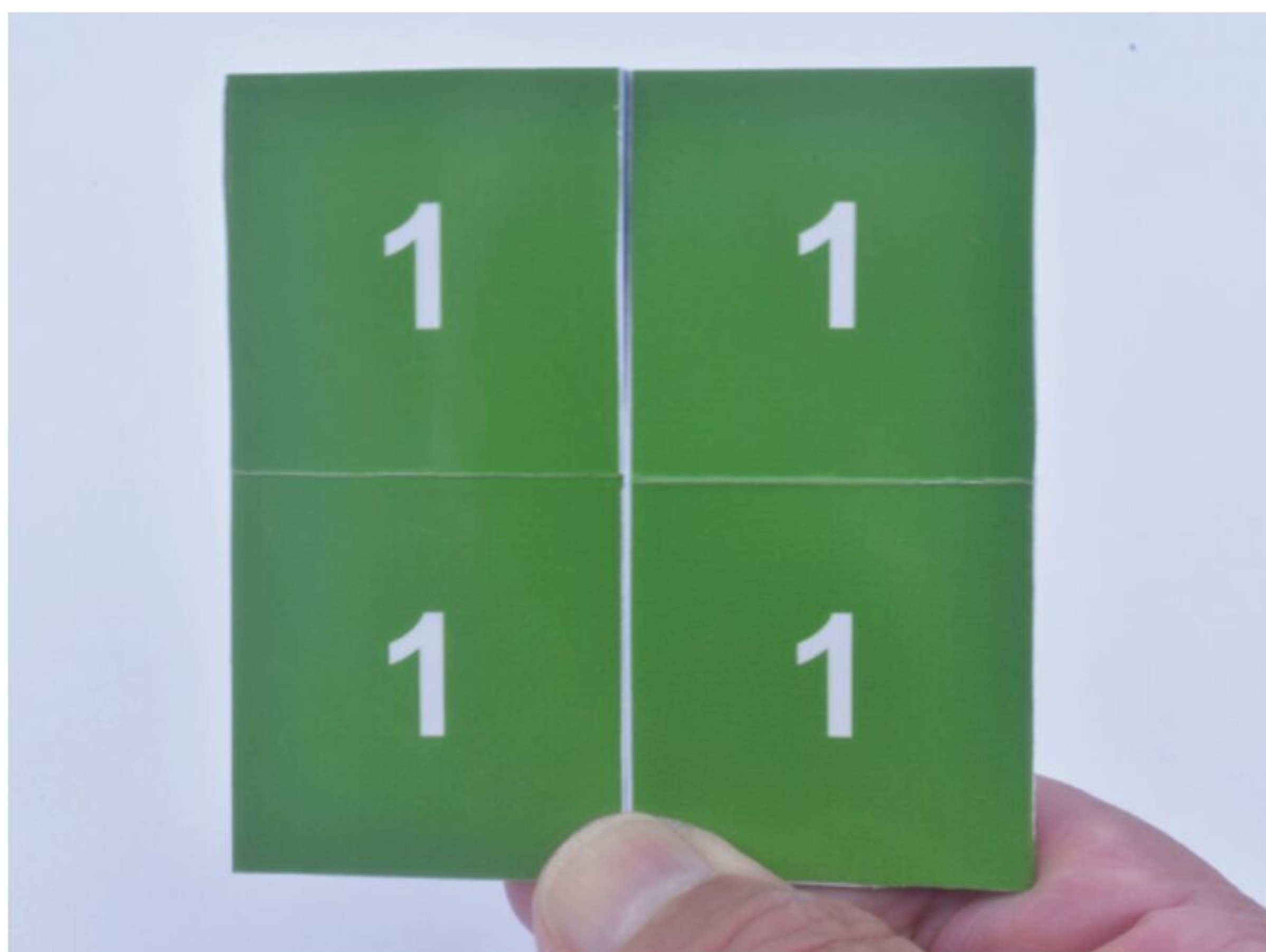

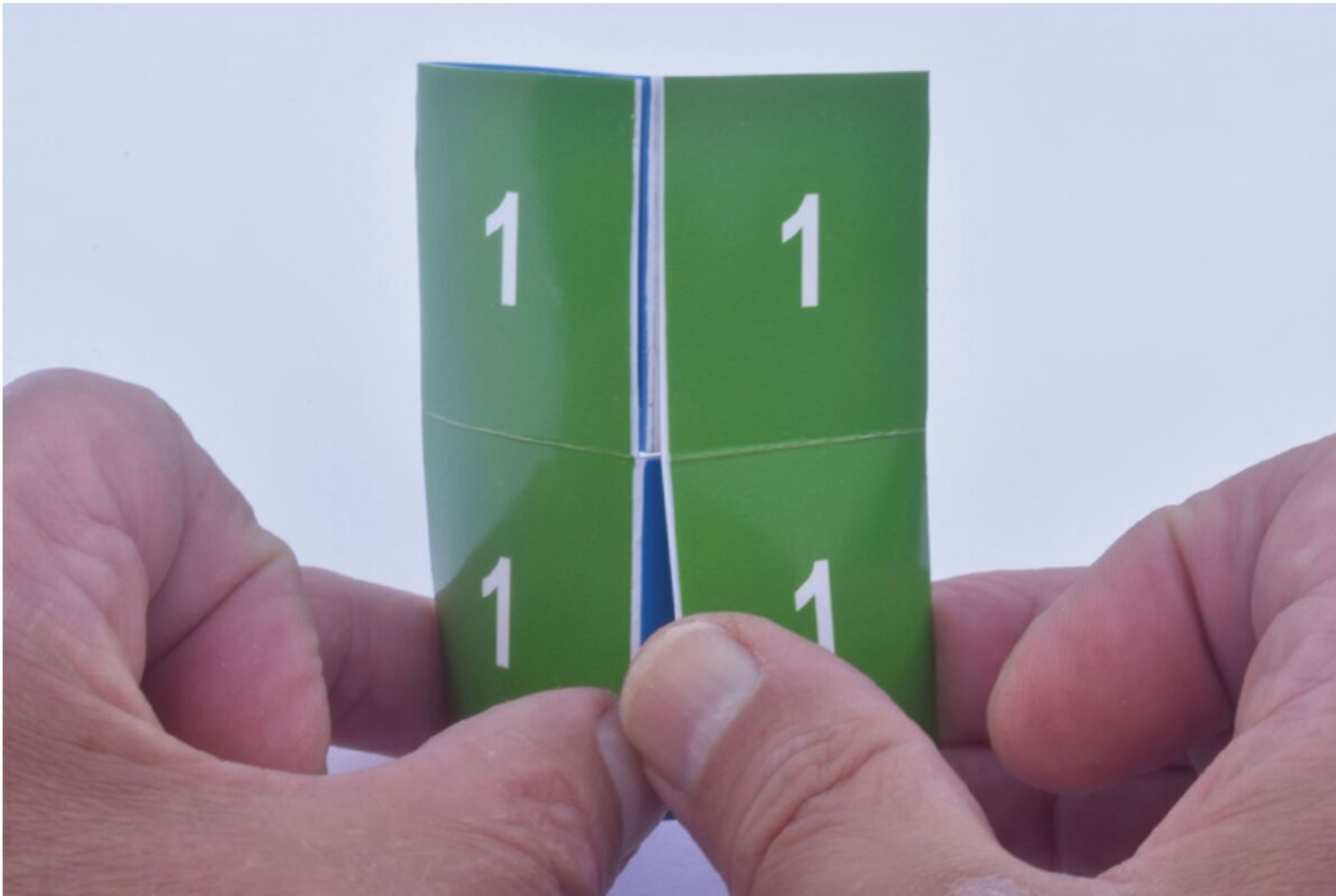

your tri-tetraflexagon as described next and illustrated in the photos on these pages.

Hold your flexagon with the four squares numbered '1' facing you – that's one of the three faces. Turn it over and you'll see four squares numbered '3' – that's the second of the three faces. Now, with the squares numbered '1' facing you again, bend the outer vertical edges of your flexagon away from you, while opening it up along the vertical centre line, to reveal four squares numbered '2' – that's your third and final face. If you then turn it over so that the face with the four squares numbered '1' is facing you, you'll find

for tetra-tetraflexagons, penta-tetraflexagons, hexa-tetraflexagons, and a whole load more types of tetraflexagons. We even found a template for a dodeca-tetraflexagon. What's more, there are several types of all of these tetraflexagons, which are made from differently shaped templates, are folded differently, and flex in a different sequence. And, best of all, we promise that they're all more exciting than the tri-tetraflexagon. Although the tetraflexagons with more sides are trickier to make, they just get more interesting the further you progress up the ladder. □

Above  The tri-tetraflexagon has two faces, numbered '1' and '3', that you can see just by flipping it over, and a third face, numbered '2', which is hidden away inside until you flex it

“ The tri-tetraflexagon might be the easiest to make, but it's just the tip of the iceberg ”

that you can flex it again, in just the same way, to return to the starting configuration. What's more, if you observe it carefully while you're flexing it back and forth, you'll recognise the now familiar double hinge assembly in operation.

We have to admit that a tri-tetraflexagon isn't wildly exciting, but don't dismiss tetraflexagons just yet. The tri-tetraflexagon might be the easiest to make, but it's just the tip of the iceberg. So, how about searching out patterns and folding instructions

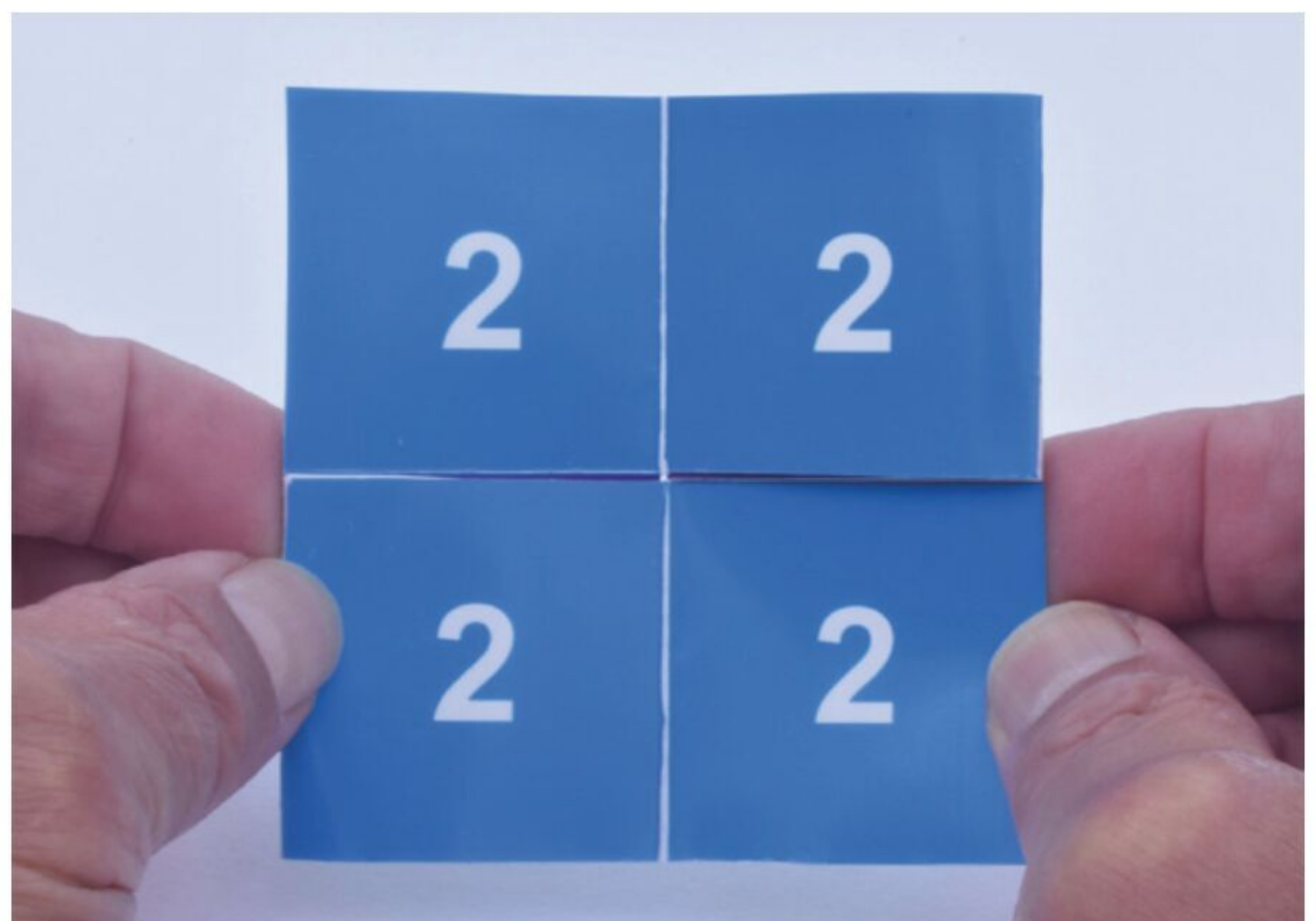

Custom-shaped protoboard

Design your own versatile PCBs



Ben Everard

@ben_everard

Ben's house is slowly being taken over by 3D printers. He plans to solve this by printing an extension, once he gets enough printers.

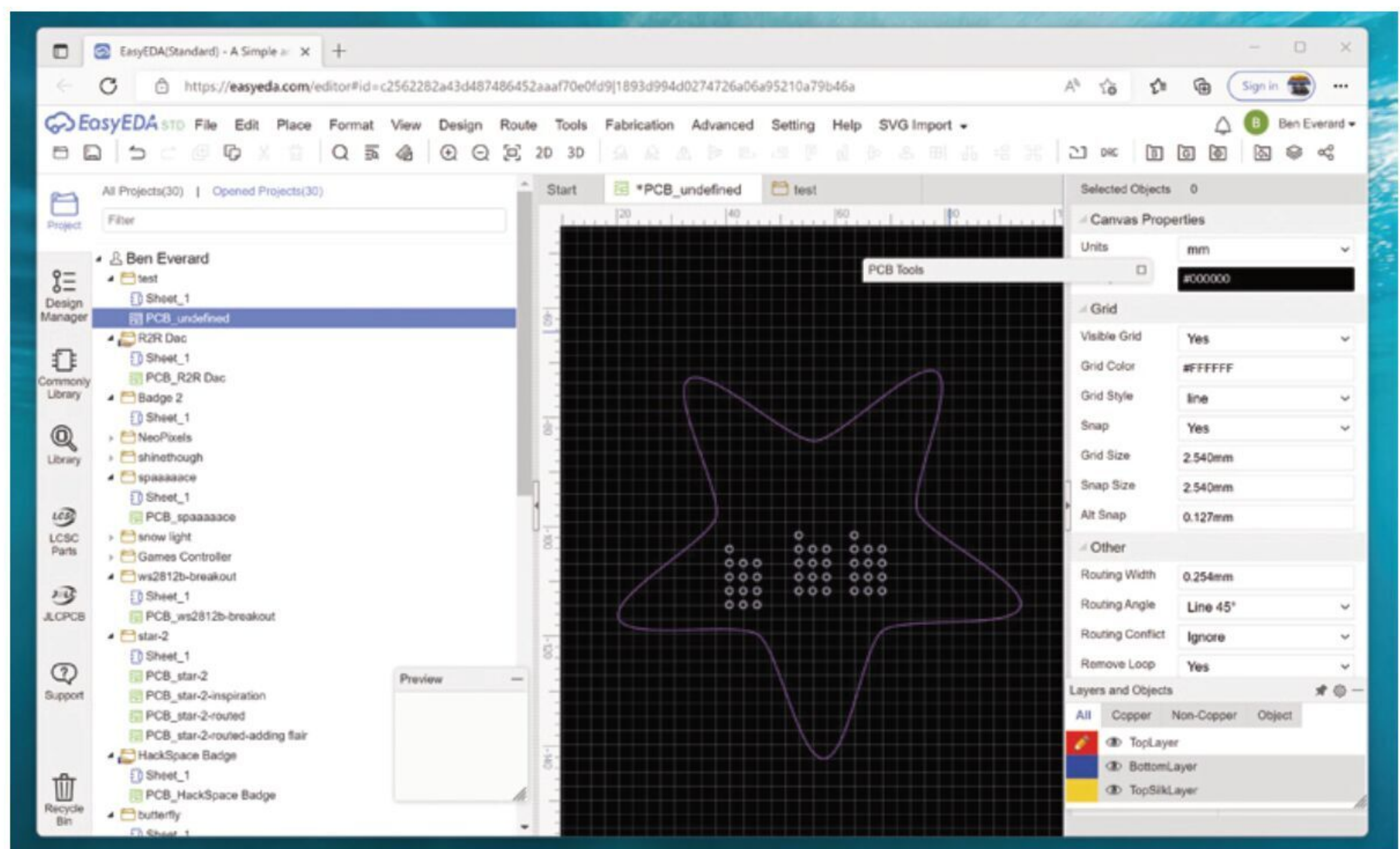

Protoboard is basically a PCB that has a lot of holes 2.54 mm apart. Why 2.54 mm? Well, it's because for some reason, electronic manufacturers have reached some compromise between metric and imperial, and release components with pins spaced 1/10th of an inch apart. We assume that this makes imperial aficionados (who would no doubt prefer an 1/8th or 1/16th of an inch) as annoyed as us who would prefer a whole number of mm. Alas, standards are standards and it has stuck.

Back to protoboard – it comes in a range of dimensions – usually rectangular, and sometimes with mounting holes. However, what if you don't want something rectangular, or if you want mounting holes in a specific place? This month, we found ourselves in exactly that situation as we started work on our Christmas PCB project – our yearly build of decorative electronics.

This time, we decided to start with protoboard in different shapes. As yet, we're undecided if the protoboard will be the final product (and we'll build different projects on it), or if we'll build some prototypes and then get them made up as finished PCBs.

This is a great first project if you're just getting started with designing PCBs, as it lets you get familiar with the process of designing and building them without the overhead of having to actually design the circuit or worry about footprints.

We've used EasyEDA – you could do this in just about any PCB design program, but the steps will be different.

First, head to the website (easyeda.com) and log in. Click on Designer. There are two modes: Standard and Professional. Standard (STD) is fine for our use.

Before we start with the project, we're going to add an extension. EasyEDA does have some ability to

Above Copy and paste blocks of pads to quickly fill the space

load image files, but it's not particularly good. There's an extension for loading SVGs that works much better and allows you to do your image manipulation. We'll use the descriptively named SVG Import Extension for EasyEDA, which you can download from hsmag.cc/svgimport.

First, download **extension.zip** and extract the files. Then in EasyEDA, go to Advanced > Extensions > Extensions Setting > Load Extension... > Select Files... and select all the files you extracted from **extension.zip**. Press Load Extension and you should now have an SVG Import item in the menu bar across the top.

Before we can use this, though, we need to create a project and a PCB. Go to File > New > Project and give it a name. This will create an entry in the box on the left-hand side of the screen; it will also create a schematic in the project. We won't be using the schematic. Right-click on the project, and select New PCB.

The new PCB will open in a tab in the editor, and the default schematic will also open in a tab. It's easy to make sure you're in the correct tab because PCBs have a grey grid on a black background, while schematics have a grey grid on a white background.

Our PCB is now ready to go, but we need to set the outline. If you want a custom-shaped rectangle (with or without rounded corners) or a circle, you can do this with Tools > Set Board Outline. However, if you want a different shape, you'll have to design it in an SVG editor such as Inkscape and then import it.

As an example, we created some star-shaped protoboard. In Inkscape, click on the star icon in the left-hand side toolbar. In the top bar, you can now set the number of corners, the spoke ratio (essentially how far in the inside corners of the star go), and how rounded you want them.

However you draw the SVG of your board outline, you just need to save it as an SVG file in Inkscape and then you'll be able to load it into EasyEDA.

In EasyEDA, go to SVG Import > Open Import and select the file you just created. It's important to select the following options:

- Import As: Track
- Import Scale: 1
- Layer: Board Outline

Then press Import. The dialog box won't disappear, but the board outline should appear behind it. Once it has, you can close the SVG Import dialog box.

The next step is to add the metal-plated holes that you can solder to. The easiest way to do this is to set

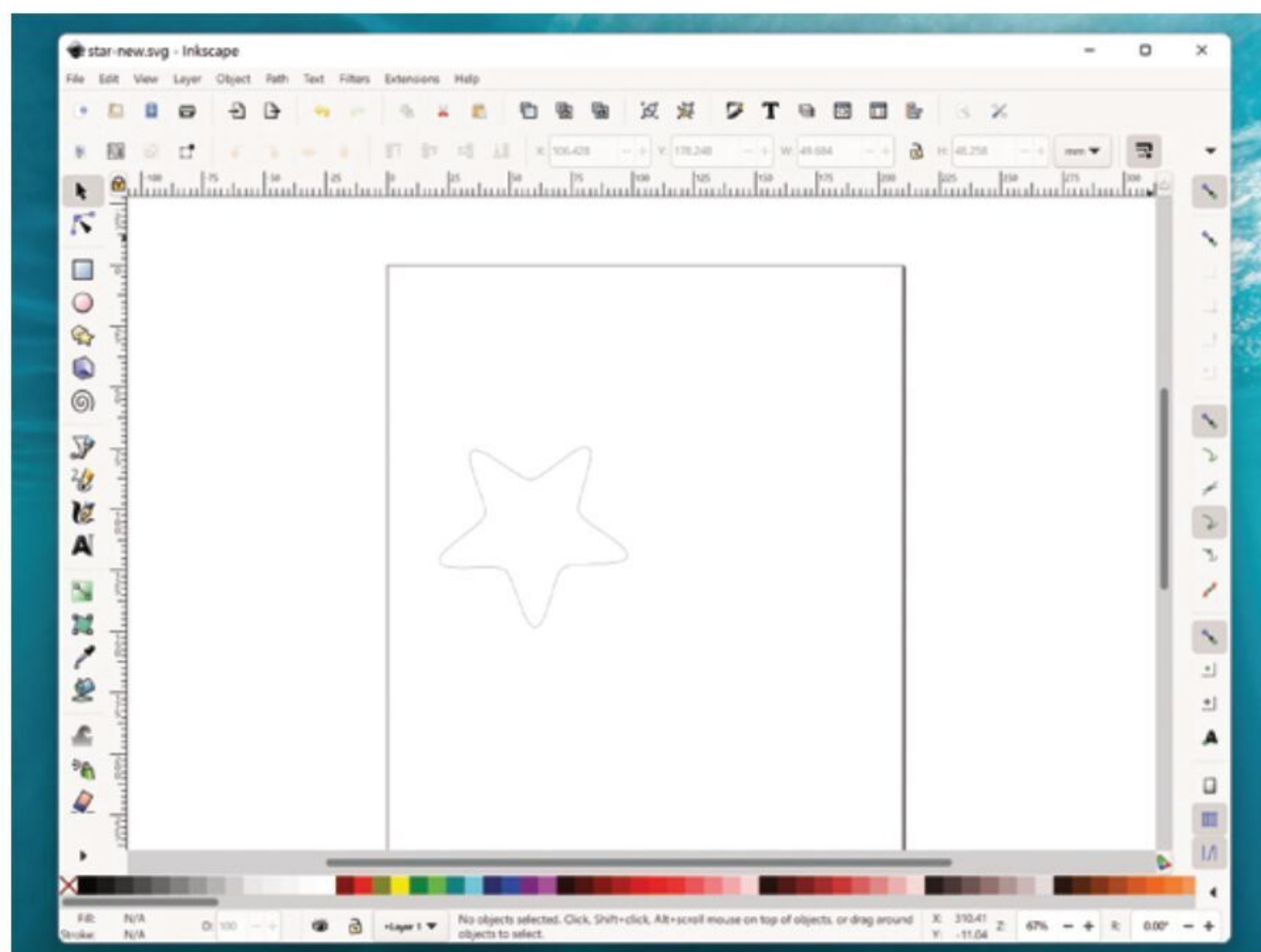

Above  Design the PCB outline in Inkscape then import it into EasyEDA

the snap size of the grid to be the spacing you want and then start placing the holes. To set the grid snap size, first, click on the background, then make sure Snap is checked. You can set the units to either mil (1/1000th of an inch) or mm. The size should be either 100 mil or 2.54 mm, depending on which units you select.

You can now select the Pad option from the toolbox and start clicking to add them. The quickest way to do this is to create a small grid of pads, then you can press **ESC** to get the pointer back and left-click, hold, and drag a box around all the pads in the grid (be careful not to select some of the board outline as well), and **CTRL+C** it to copy. You can then keep pressing **CTRL+V** to paste blocks of these rather than having to put in each individual pad.

As well as filling up space with holes, you might also want to add some mounting holes. This is done with the Hole tool. Just select the tool and click where you want it to go.

Once you've got the board set up how you like, you can press the 3D button to see what the PCB will look like, and if it all looks correct, go to Fabrication > PCB Fabrication File (Gerber). This will let you order it online, or download a zip file that you can take to any fabrication service you choose.

You don't have to limit yourself to just plain protoboard, of course. You could add footprints for some components and link this up to the protoboard, or change it in some other way. The advantage of personalised protoboard is that you can make it however you like. 

Modifying designs with PrusaSlicer

The 3D printer software can do much more than just generate G-code



Ben Everard

@ben_everard

Ben's house is slowly being taken over by 3D printers. He plans to solve this by printing an extension, once he gets enough printers.

Sometimes you find a design you want to print, but it's not quite right. It's nearly there, but just needs a little tweak. Perhaps the original designer hasn't shared the design files, just the printable STL, or perhaps it was designed in some software that you don't use. Let's take a look at some really simple modifications that you can do in PrusaSlicer.

CUTTING IT UP

Perhaps the object is too big for your printer, or perhaps you just need half of it. Let's take a look at how to cut an object into little bits. There are a couple of limitations to the way that the cut tool works. Firstly, it only cuts horizontally parallel to the print bed. That means that you have to first rotate your object so that it's pointing in the right direction.

When using the rotate tool, a protractor will appear on the screen which has lines for each multiple of

45 degrees. If you put your mouse towards these, it will snap to these angles, making it easy to rotate to exactly 90 degrees. Move your mouse away from these lines and you can rotate freely to any angle.

Once the rotation's done, you can then perform the cut using the cut tool and keep either or both halves.

One slight complication is, if you're cutting a piece into parts in order to print each one separately, you probably want to save the work with all the parts, but only print one at a time. You can do this by moving all the parts you don't want to print in a particular print off the print bed, then slice as you usually would, and it will only slice the parts on the print bed.

ADDING HOLES

Putting holes in an object might seem a bit odd, but it's surprisingly useful because it lets you easily screw in additional pieces of hardware. Want to mount a microcontroller? Mount your print on a wall, or stick two prints together? Add some screw holes.

Select the part you want to hole, and right-click. In the menu, select Add Negative Volume > Cylinder. This will add a 3cm diameter negative cylinder to your object. You can scale to the correct size and move it to the right place. For some cases, you can just move it by eye. However, if you need precise placement, you can type the co-ordinates into the position boxes in the right-hand pane. You won't see the negative space in the preview pane, but once it slices, you will see the holes.

While screw holes are probably the most common thing we use this

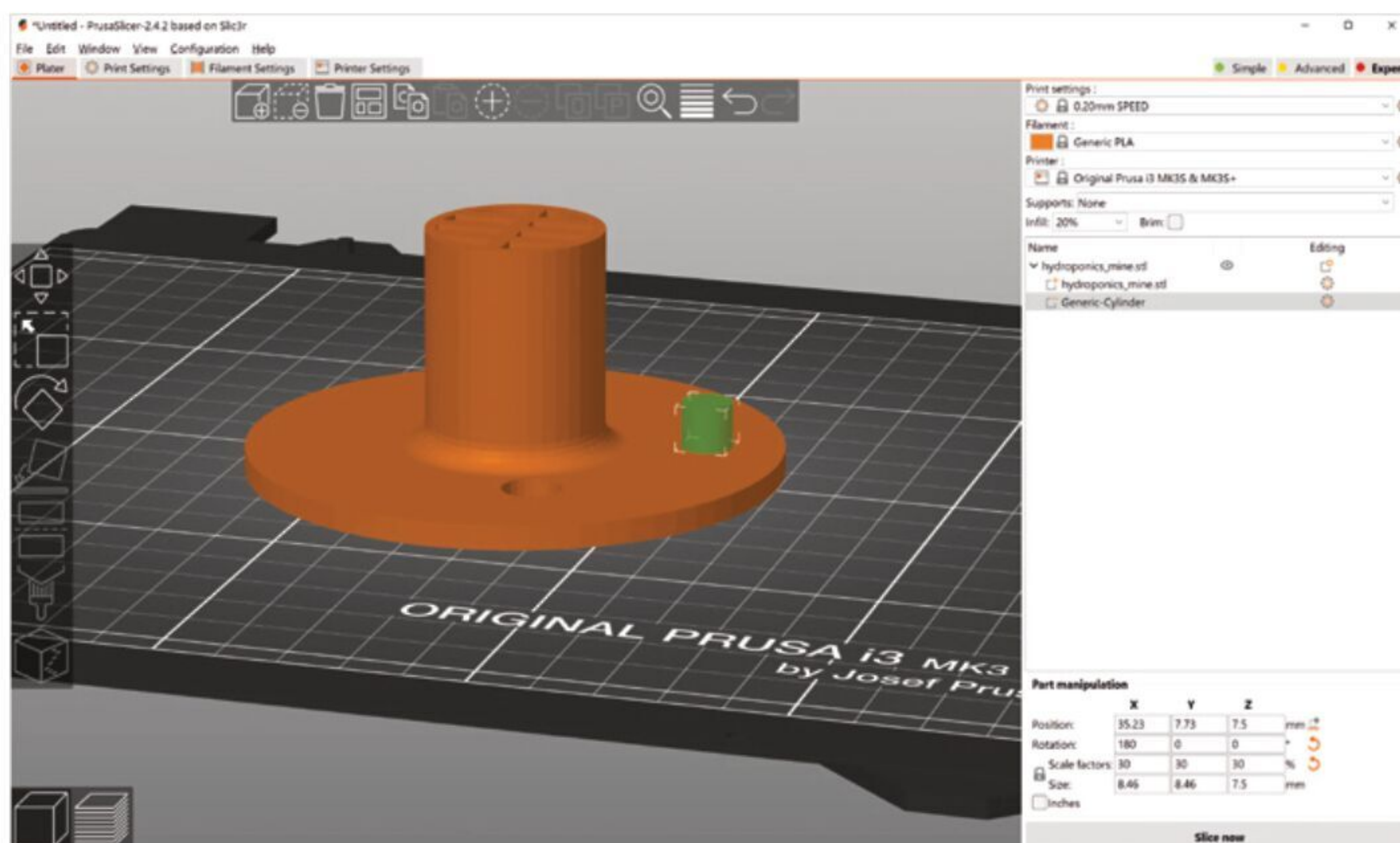

Left Add holes to your 3D prints

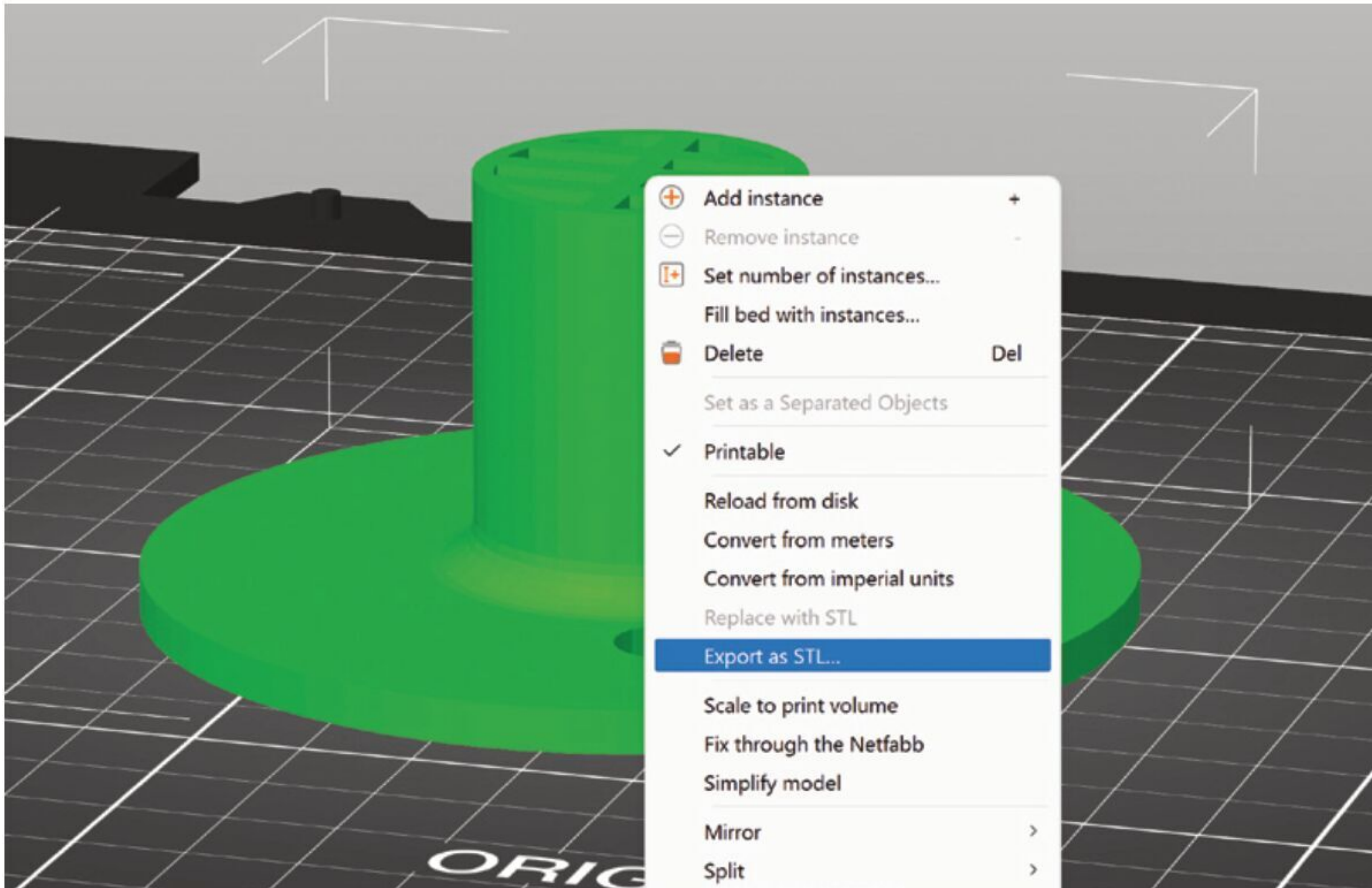

“ If you need precise placement, you can type the co-ordinates into the position boxes in the right-hand pane ”

for, you can also use it to create recesses for adding electronics, or any other purpose where you want to cut a chunk out of a 3D print.

LOW POLY

Modern 3D design software can create fantastically detailed models, but some of us who came of age in the last millennium still have some nostalgia for simpler days when 3D renderers could only handle simpler designs. You can reduce the polygon count to recreate this effect from yesteryear. Select an object in the preview pane, and right-click on it. Select simplify, and then you can enter the level of detail you want. We found that we had the best results by selecting Decimate Ratio and then clicking on the pen icon to enter the details by hand. We found we got good results with a decimate ratio of about 99.6%. However, this will depend a lot on the particular model selected.

EXPORT AS STL

In most cases, you’ll probably want to save your modifications as a PrusaSlicer project, because this keeps details of what parts things are made up from and allows you to make more precise modifications in the future. However, if you’re sharing the file with others, you may want to share the file as an STL. Fortunately you can export your newly modified model as an STL file. You can do this in two ways. If you want to export the entire build plate as a single STL file, go to File > Export > Export Plate as STL. If you just want to export one of the objects on the build plate, you can do this by highlighting that object and right-clicking on it, then selecting Export as STL.

Whichever way you do it, you’ll get a file dialog where you can give it a name and select a place to save it. □

Above □ Export your changes to share with others

Below ◆ Turn high-res models into 1990s-style, low-poly objects

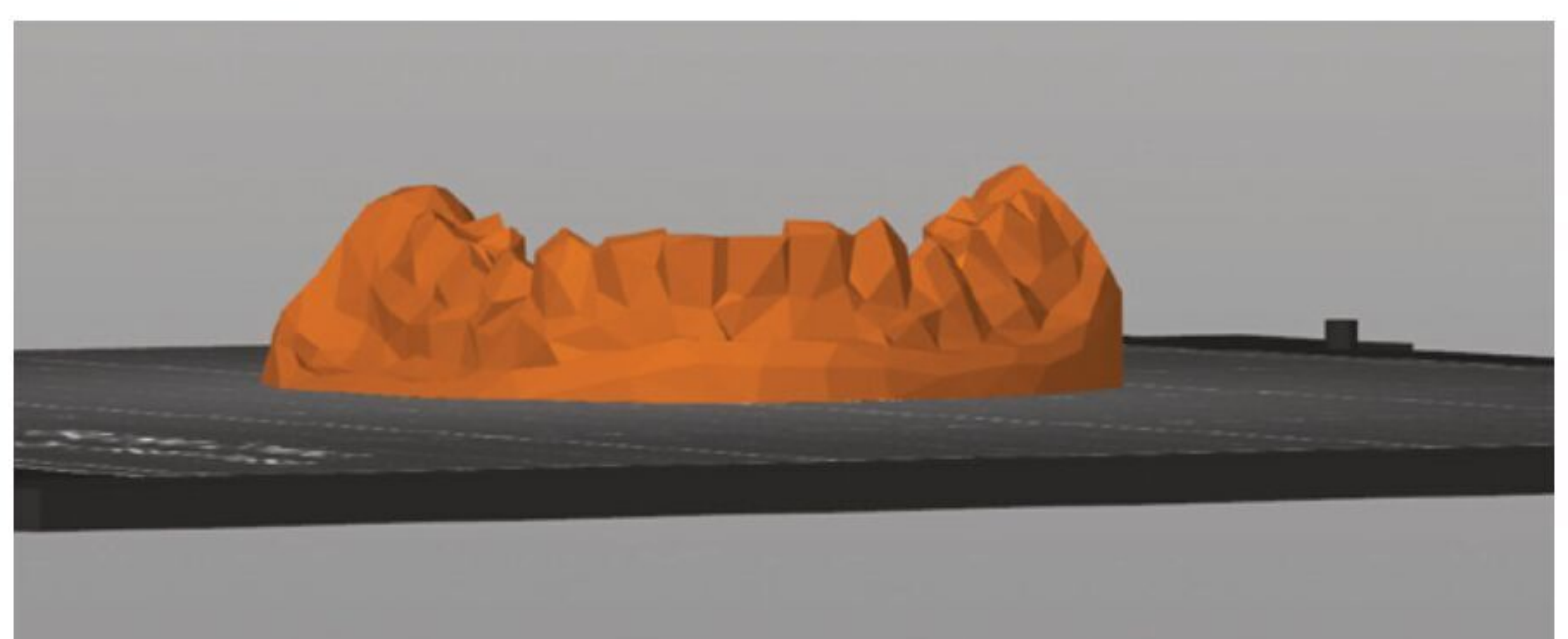



Build a Makerspace for Young People

Join our **free online training course on makerspace design** to get expert advice for setting up a makerspace in your school or community.

Sign up today: rpf.io/makerspace

BOOK OF MAKING

VOLUME 2



**ONLY
£10**

WHSmith
BARNES & NOBLE

Available on the
App Store

GET IT ON
Google Play

**THE BEST
PROJECTS FROM
HACKSPACE
MAGAZINE**

THE ULTIMATE SKILLS,
TRICKS, AND MAKES

AVAILABLE NOW

hsmag.cc/store

FROM THE MAKERS OF **HackSpace** MAGAZINE

Sublimation printing onto PCBs

Make your circuit boards more colourful

If you read HackSpace magazine regularly, you'll know that we've been experimenting with colour printing onto PCBs. After running through quite a few tests, we've now got a bit of an idea what works and what doesn't. This is still an experimental process, so good results aren't guaranteed, but this works for us.

Sublimation printing is a process where you use a desktop printer that looks a bit like a regular inkjet printer (but is in fact a dedicated sublimation printer), to print onto a special type of paper. You can then put this paper on top of a different material and heat the whole to up to about 190°C, and the ink from the paper 'sublimates' into a gas and transfers onto whatever it's pressed against. It allows you to transfer detailed images onto surfaces you couldn't normally print on. It's widely used to make T-shirts, mugs, and other things with colourful designs. However, it only

works with a few materials and, typically, you have to get dedicated 'sublimation blanks' for it to work.

The first thing you'll need, then, is a sublimation printer. These are quite widely available but, if you don't have one, there are services that will print your designs and send you the printed sheet. Take a look at local print shops, or on Etsy or eBay, for people offering this service.

Whichever way you do it, you'll just need an image that you want to transfer. Obviously, this will depend entirely on your PCB. We've used swirling images for backgrounds, NASA space photography, and Christmas design patterns. It's up to you what you want to put on your PCB.

The second thing that you need is a PCB. We've experimented with white solder mask and white silkscreen. While solder mask doesn't work very well, and it's much better to get a white silkscreen over

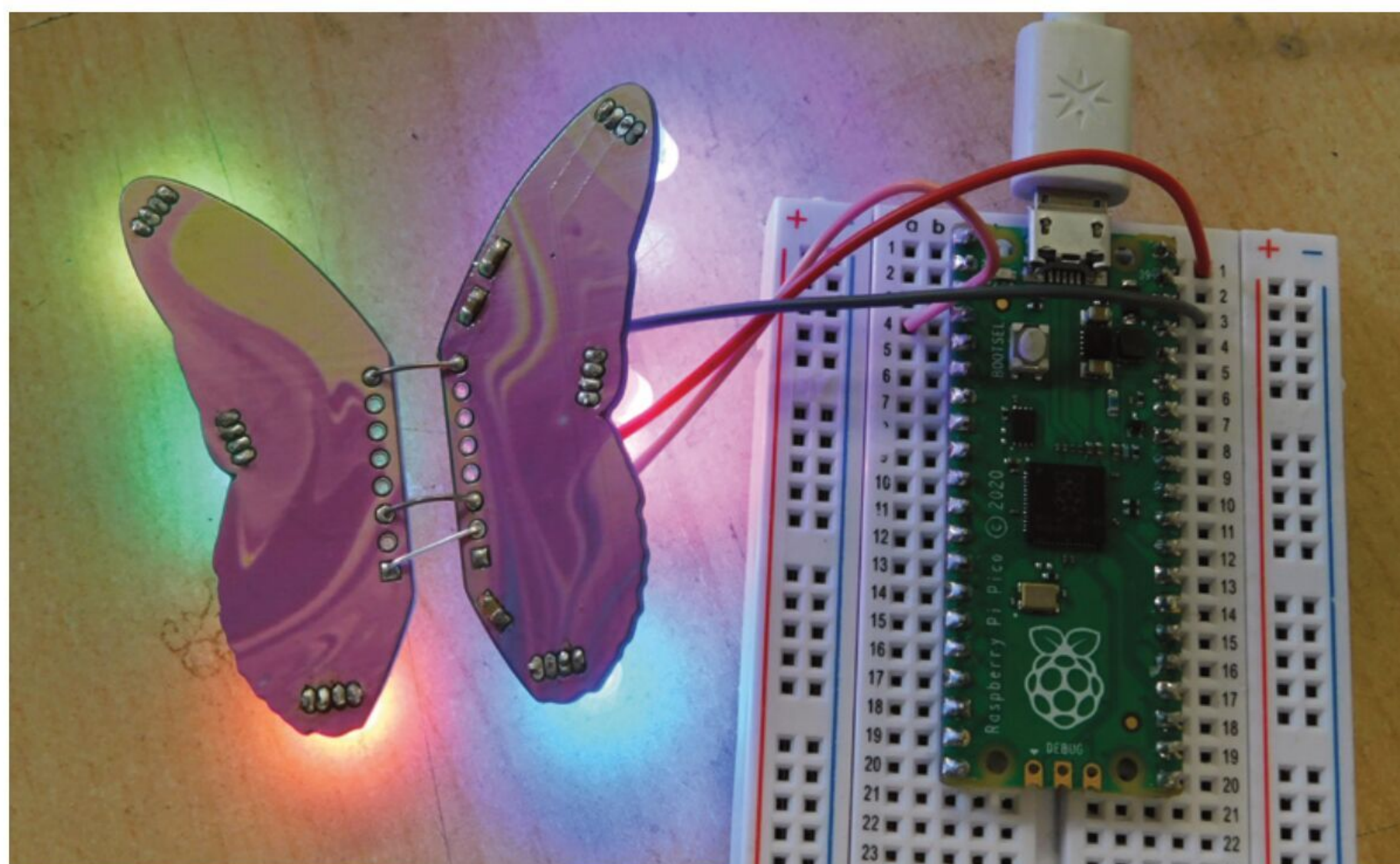

Right  You can solder onto the PCB as usual and use IPA to clean it without affecting the print



Left  Get white PCBs, stick to your sublimation paper, and heat-press on the design

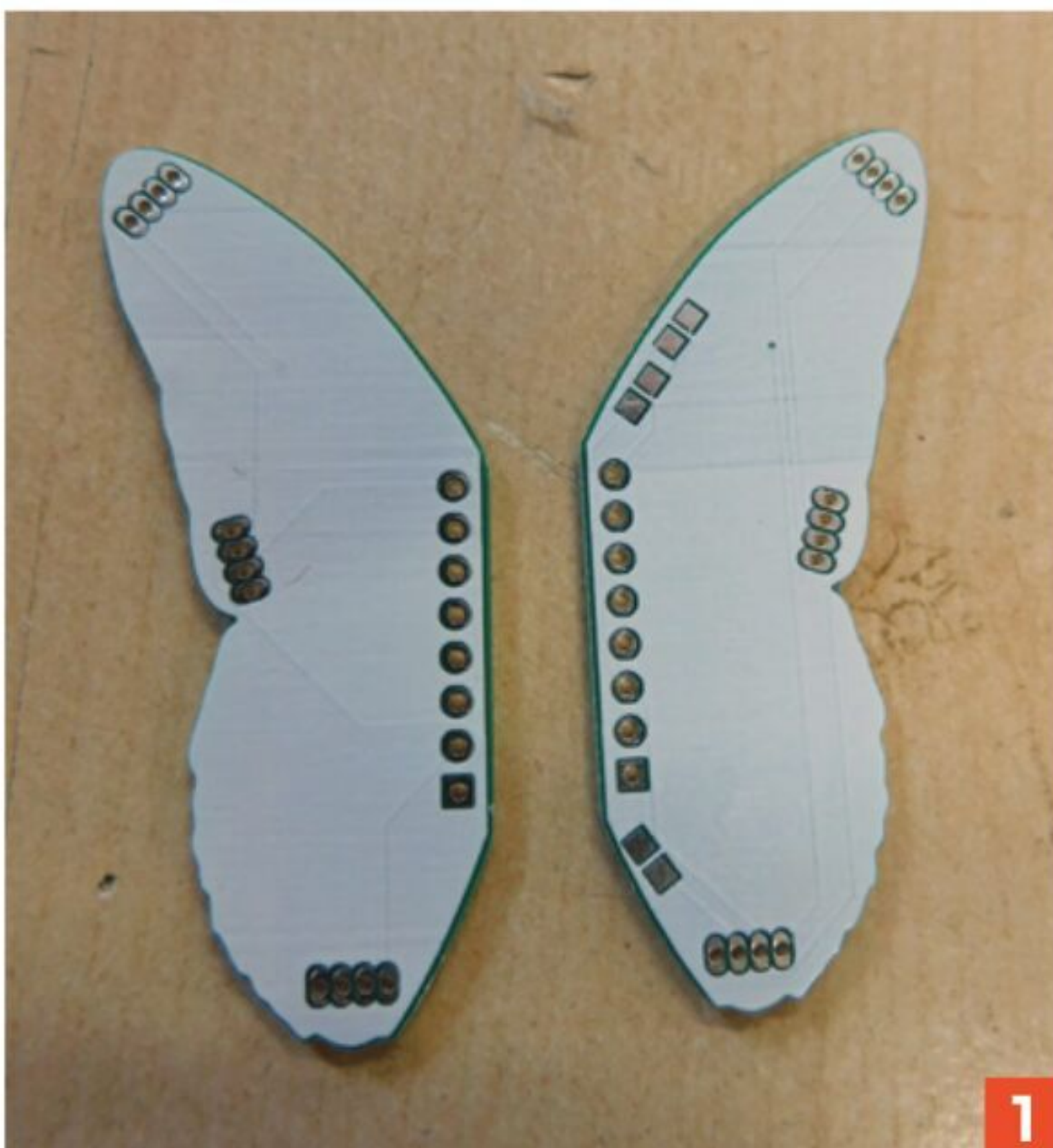

It allows you to transfer detailed images onto surfaces you couldn't normally print on



the entire PCB. The easiest way of doing this is by drawing a rectangle of silkscreen over the entire PCB. However, this will put silkscreen over the solder pads. This may not be a problem, as most PCB fabricators will automatically trim the silkscreen layer to not place any over pads. However, it's better not to rely on this. In KiCad, for example, there is an option to clip the silkscreen when you generate the Gerber.

There are different types of silkscreen, and we've only tested this with traditional silkscreen rather than inkjet silkscreen.

Once you have the two parts, you need to heat-press the design onto the PCB. We pressed at 190°C for 50 seconds, though you might need a bit of experimentation to get this right. It might also be possible to do this with an iron, but we haven't tested this.

That's it. That's the process for sublimation printing onto PCBs. There are a lot of variables, including the exact ink that your PCB fabricator works with (we used PCBWay), so we'd recommend testing this out with a small PCB first, rather than diving straight into a large order. 

DON'T MISS THE **BRAND NEW** ISSUE!



**SUBSCRIBE
FOR JUST
£10!**

- ▶ **THREE!** issues of The MagPi
- ▶ **FREE!** Raspberry Pi Pico W
- ▶ **FREE!** delivery to your door

**+ FREE
RASPBERRY PI
PICO W***

Three issues and free Pico W for £10 is a UK-only offer. Free Pico W is included with a 12-month subscription in USA, Europe and Rest of World. Not included with renewals. Offer subject to change or withdrawal at any time.



magpi.cc/subscribe

FIELD TEST

HACK | MAKE | BUILD | CREATE

Hacker gear poked, prodded, taken apart, and investigated

PG
108

INVENTOR 2040 W

A dev board within
a dev board



PG
112

FOLDING SCALPEL

Keep your blades sharp
and your fingers safe



PG
102

BEST OF BREED

Software-defined radios
to let you reconfigure your
receiver on the fly





Software-defined radios

A collection of SDRs available on Crowd Supply

By **Marc de Vinck**

@devinck

Crowd Supply. Heard of it? If not, you really should investigate this alternative model to the typical crowdfunding sites. It only features electronic and electronic-related products, and helps take out much of the risk involved in typical crowdfunding. How? Let's take a quick look at its business.

First and foremost, if you decide to back, or pre-order a product, there is still some risk, but Crowd Supply has greatly reduced this risk through a few very important guiding principles. First, it's a curated collection. You can't simply put up your dream of a hoverboard and expect it to be accepted without some proof of concept.

Second, and this is a big one, it helps fund the project by typically contributing or matching 50% – 100% of the total funds raised by individual backers. This means that it has a vested interest in the creators succeeding. And the third biggest difference, in my opinion, between Crowd Supply and other platforms, is its in-house experts. It can help source, build, and

later support the products. And it wants to – remember, its money is invested too!

It's an interesting platform that deserves more attention, and that's where this Best of Breed comes into play. I'll be looking at some technically advanced projects on Crowd Supply that are all related to software-defined radios (SDRs). These are typically highly engineered products that hard-core developers

use for processing digital signals.

I'm certainly not an expert in this area, as I've only tinkered with very basic SDRs in the past, looking at some transponders on aircraft and ships, but their applications are much more far-reaching. If

your project uses wireless signals, then you most likely know what a software-defined radio is and, hopefully, this article gives you a basic guide to some of the SDRs on the market outside of the big commercial manufacturers.

“ If your project uses wireless signals, then you most likely know what a software-defined radio is

”

█ All the products in this Best of Breed have been funded and are available for ordering or pre-ordering.

CaribouLite RPi HAT vs LimeSDR Mini 2.0

CROWD SUPPLY ◆ \$71 - \$138 | crowdsupply.com

CROWD SUPPLY ◆ \$399 | crowdsupply.com

Yes, our beloved Raspberry Pi Zero has a HAT to convert it into an affordable dual-channel SDR.

The CaribouLite was specifically designed for the DIY community to allow full control of the FPGA

hardware, software, and firmware. The HAT features a dual-channel radio that spans frequency from 30MHz to 6GHz on Channel 1 and Sub 1GHz on Channel 2.

There is a lot more specific information on the website about the frequency ranges as tested, so be sure to head over and look at the details to see if this board will fit into your workflow. And, as with all the boards in this roundup, be sure to understand all the legalities of the way you use your SDR in your specific region.

For such a small and incredibly affordable board, as far as SDRs are concerned, the CaribouLite still manages to pack a powerful punch. It makes for a great first SDR, especially if you are familiar with the Raspberry Pi ecosystem and already have one ready to put to work.



Left ◆
Compact and easy to use

Below ▣
Now made with parts that are available

The latest successor to the extremely popular LimeSDR product range, all of which come from Crowd Supply and have managed to raise more than \$5 million collectively, is the LimeSDR Mini 2.0.

It's a drop-in replacement for the LimeSDR Mini and, like its predecessors, the board features an FPGA coupled with the Lime Microsystems LMS7002M RF transceiver.

Supply chain issues have crippled many hardware startups – trust me, I know the pain all too well, and the creators of the LimeSDR Mini 2.0 took on those challenges by sticking with the same form factor as the original LimeSDR Mini boards, and many of the

same components, but included a new, much more available FPGA. Smart move!

The board features a frequency range of 10MHz to 3.5GHz, a sample depth of 12 bits at a 30.72 MSPS sample rate. It's fully open-source, and is a great option that is available at a time when many other options are not. And, just like all the boards in this roundup, you really have to head over to the product page for the full details, as there are just too many to list. →

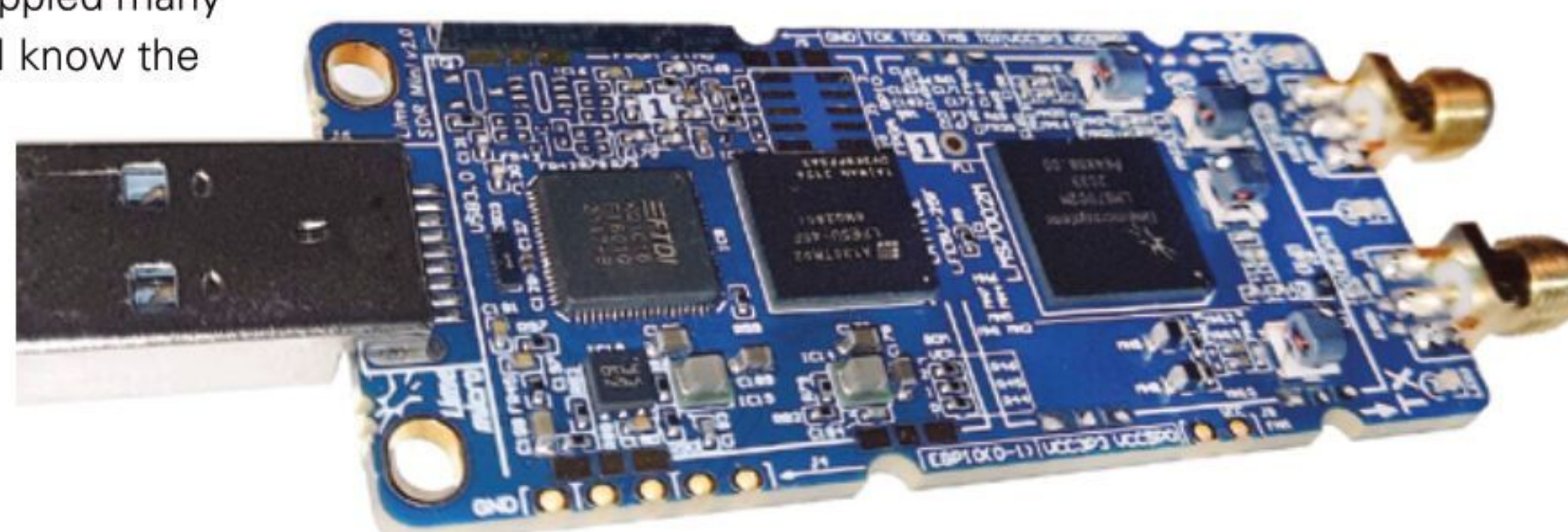

VERDICT

CaribouLite
RPi HAT

A mini Raspberry Pi-Powered SDR. What's not to love?!

10/10

LimeSDR Mini 2.0

A great addition to the Lime family.

10/10

KrakenSDR

CROWD SUPPLY ◆ \$399 | crowdsupply.com

“**R**elease the KrakenSDR” is an appropriate slogan from the makers of the KrakenSDR phase-coherent SDR with five coherent-capable RTL-SDs. Yes, five!

Couple all those channels with the common clock source, and you can build some interesting technology into your next project. You can track unknown transmitters, locate emergency beacons, passive radar detection, try beamforming, and a lot more.

The Kraken is another SDR that runs on a Raspberry Pi, making it a great choice for many hobbyists since it's such a familiar platform. They have also developed a nice ecosystem around the board, including an easy-to-use web interface, and a custom Android app. The makers have also sourced the parts for a first batch of 1000 units, and they are available at the time of this review.

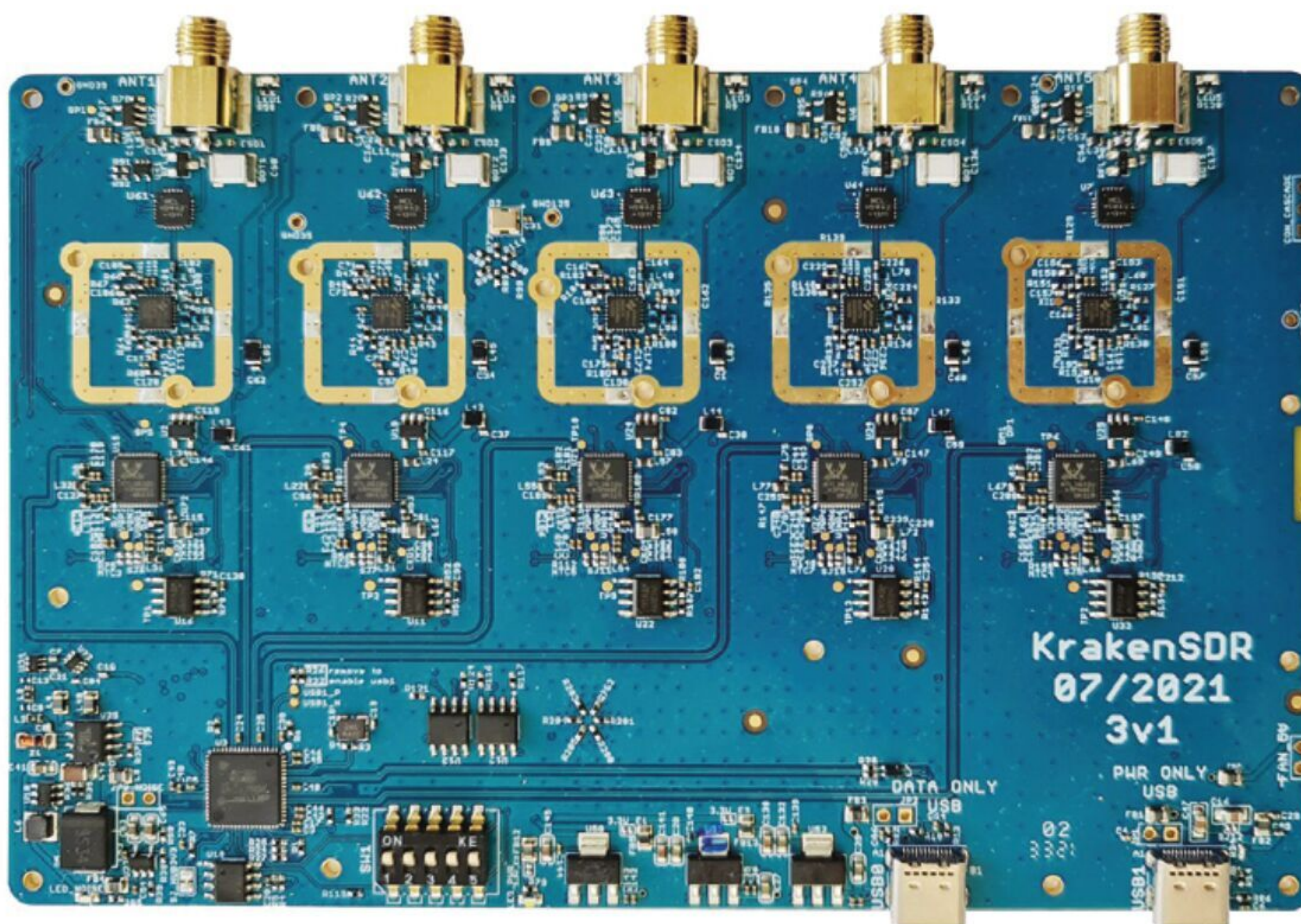
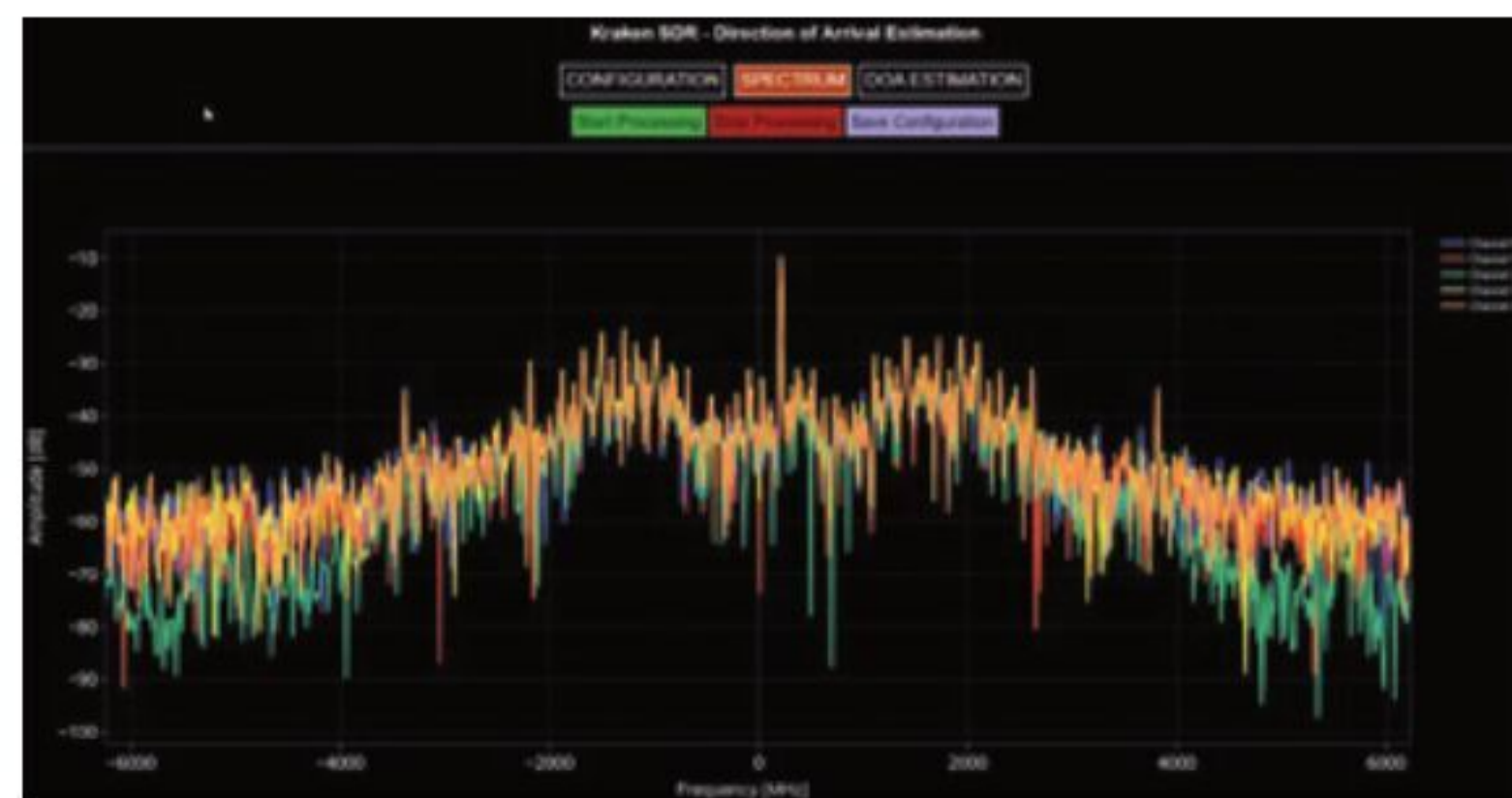
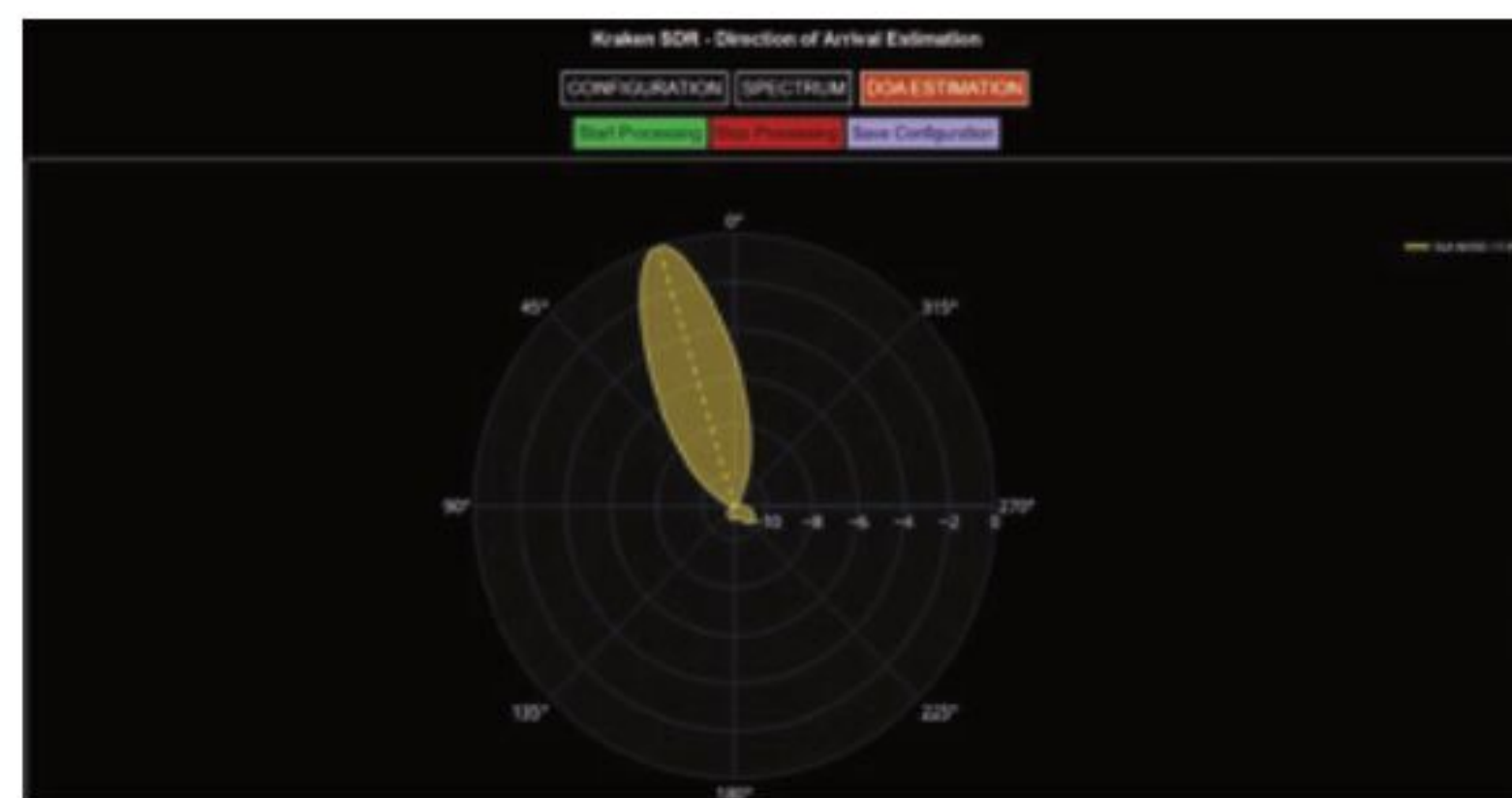

Left ◆
What's better than one SDR? Five SDRs

VERDICT

KrakenSDR

A great multi-antenna SDR.

9/10

Artificial Intelligence Radio-Transceiver

CROWD SUPPLY  \$5500 | crowdsupply.com

With three integrated processors, the Artificial Intelligence Radio-Transceiver (AIR-T) is capable of harnessing all that power, and leverage machine learning, to allow for fully autonomous signal identification and interference mitigation. There is even an embedded GPU for real-time, wide-band digital signal processing and deep learning.

And yes, this is all getting way above my skill set, but that also makes it incredibly intriguing – to learn more about the state-of-the-art in machine learning and SDR technologies. The AIR-T comes preloaded with AirStack, which includes all the components necessary to run an Ubuntu-based OS, the AIR-T-specific drivers, and the Xilinx Artix-7 FPGA firmware. If you'd like to integrate TensorFlow, Caffe, Keras, or PyTorch with an SDR, along with six CPU cores, then you should check out the AIR-T. Just make sure that you really need its power, because it comes at a fairly high price. →

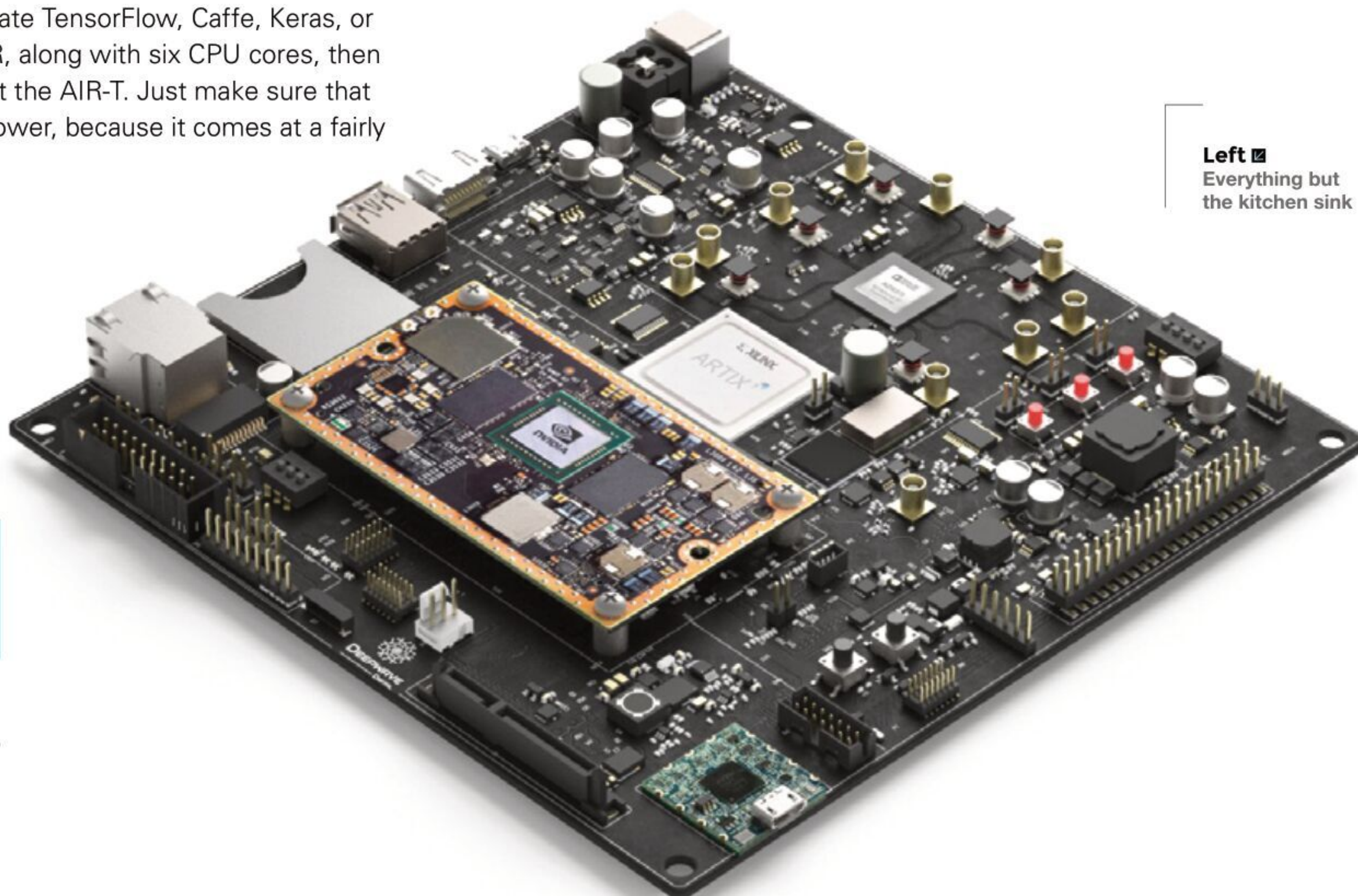
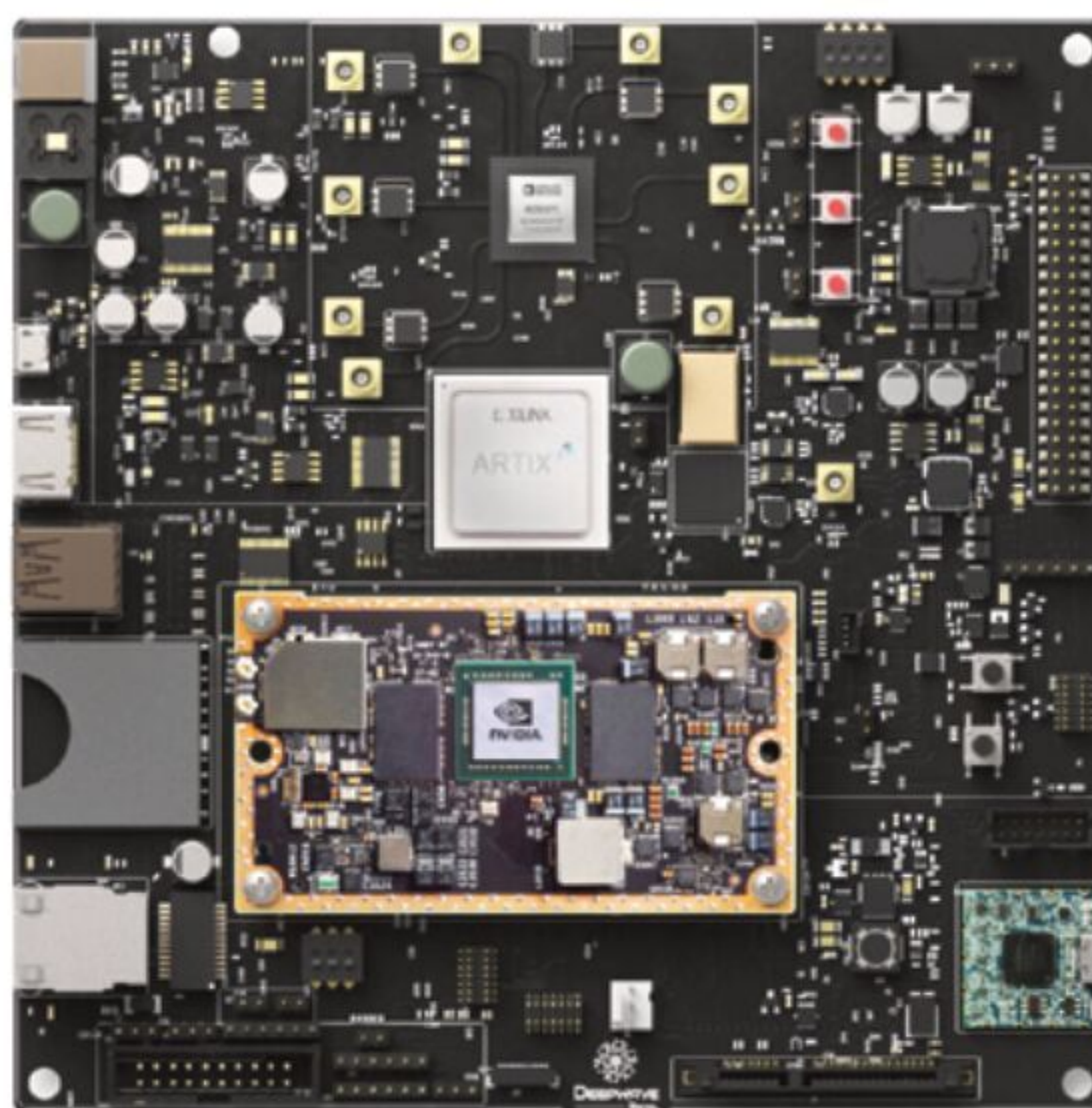

Left  Everything but the kitchen sink

VERDICT

Artificial
Intelligence
Radio
Transceiver

Amazing performance, albeit at a higher price point.

8/10

iotSDR

CROWD SUPPLY ◆ \$699 | crowdsupply.com

With the rise of the Internet of Things (IoT) over the past few years, there is a need for new ways to develop, test, and deploy high-complexity wireless frameworks.

The iotSDR platform allows SDR developers and enthusiasts to design innovative algorithms in multiband and multimode environments of all the current IoT standards. LoRa, Sigfox, Weightless-P, NB-IoT, Zigbee, and of course, Bluetooth are all compatible. And if none of those ecosystems work for you, the iotSDR can be used to develop your own custom modulation.

It works as a development environment, or as a deployable gateway, and looks to be extremely expandable and versatile. You can use a variety of popular open-source software packages in conjunction with the iotSDR, like Xilinx PYNQ Python, Jupyter Notebook, GNU Radio, and more. □

VERDICT

iotSDR

FPGA and a GNSS chip for combined power.

8/10

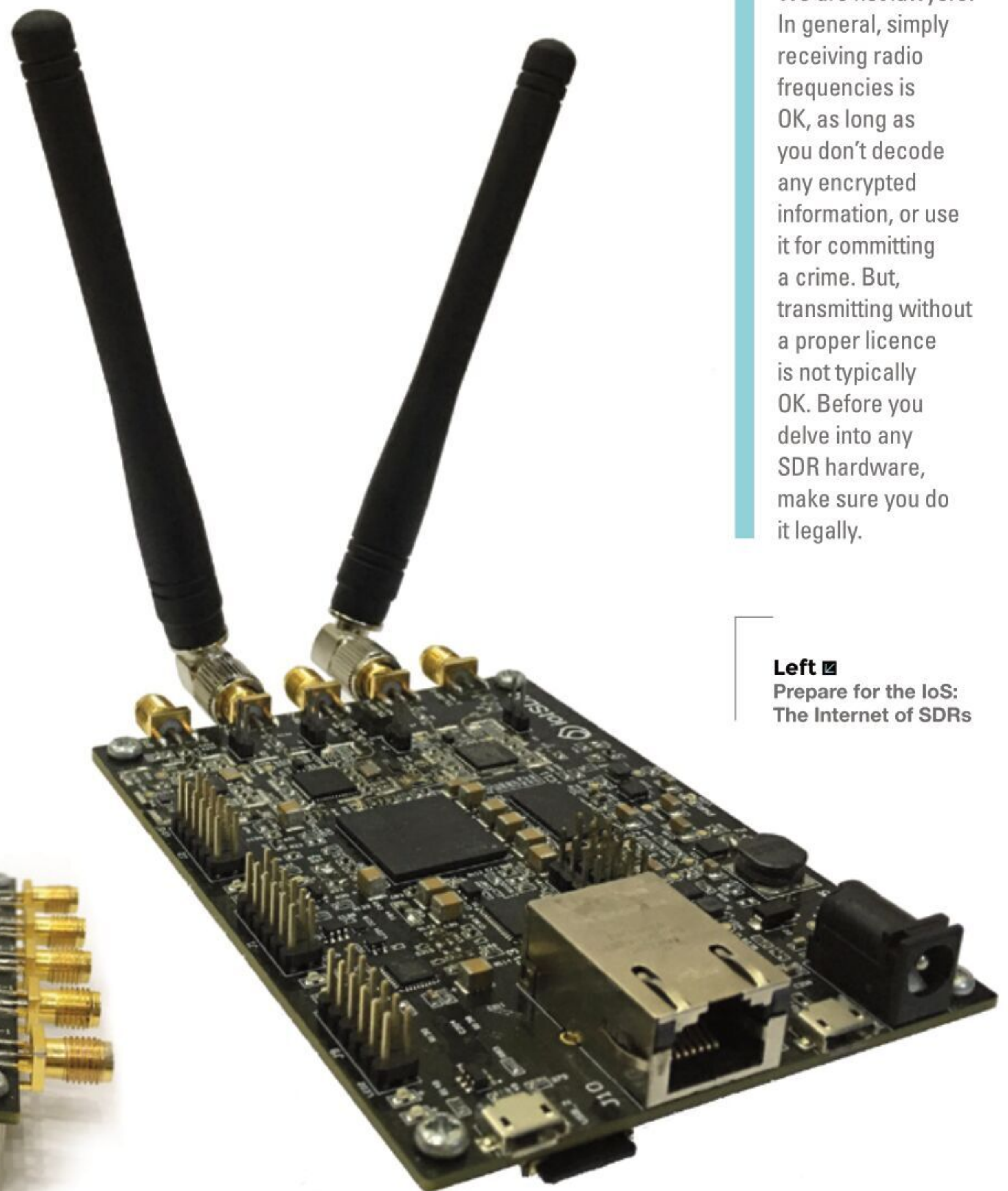

KNOW THE LAW!

We are not lawyers! In general, simply receiving radio frequencies is OK, as long as you don't decode any encrypted information, or use it for committing a crime. But, transmitting without a proper licence is not typically OK. Before you delve into any SDR hardware, make sure you do it legally.

Left □ Prepare for the IoT: The Internet of SDRs

THE *Official*

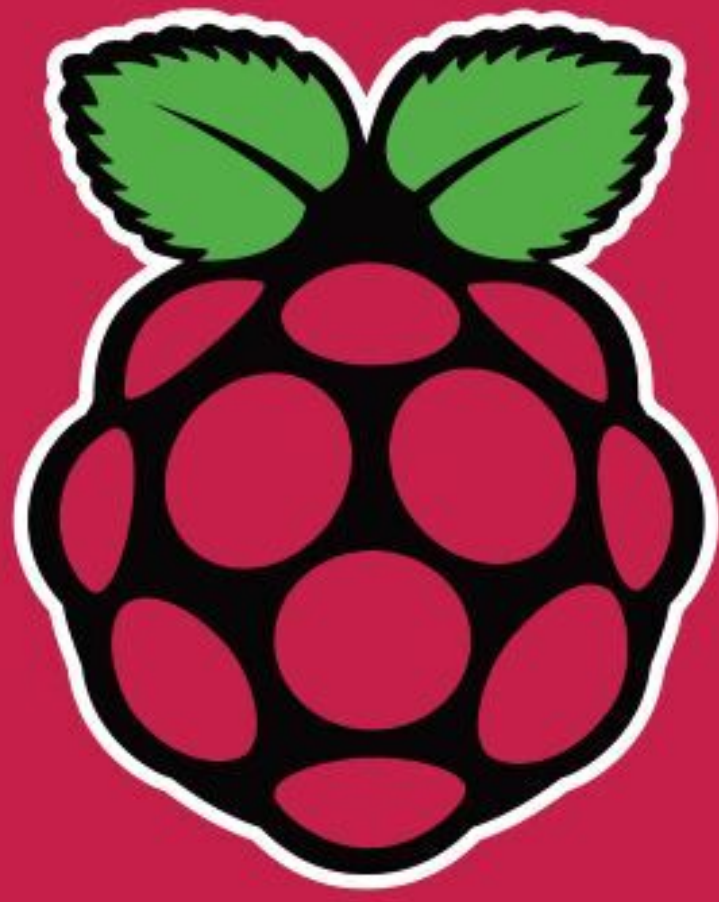

RASPBERRY PI HANDBOOK

2022

200 PAGES OF RASPBERRY PI

- QuickStart guide to setting up your Raspberry Pi computer
- Updated with Raspberry Pi Pico and all the latest kit
- The very best projects built by your Raspberry Pi community
- Discover incredible kit and tutorials for your projects

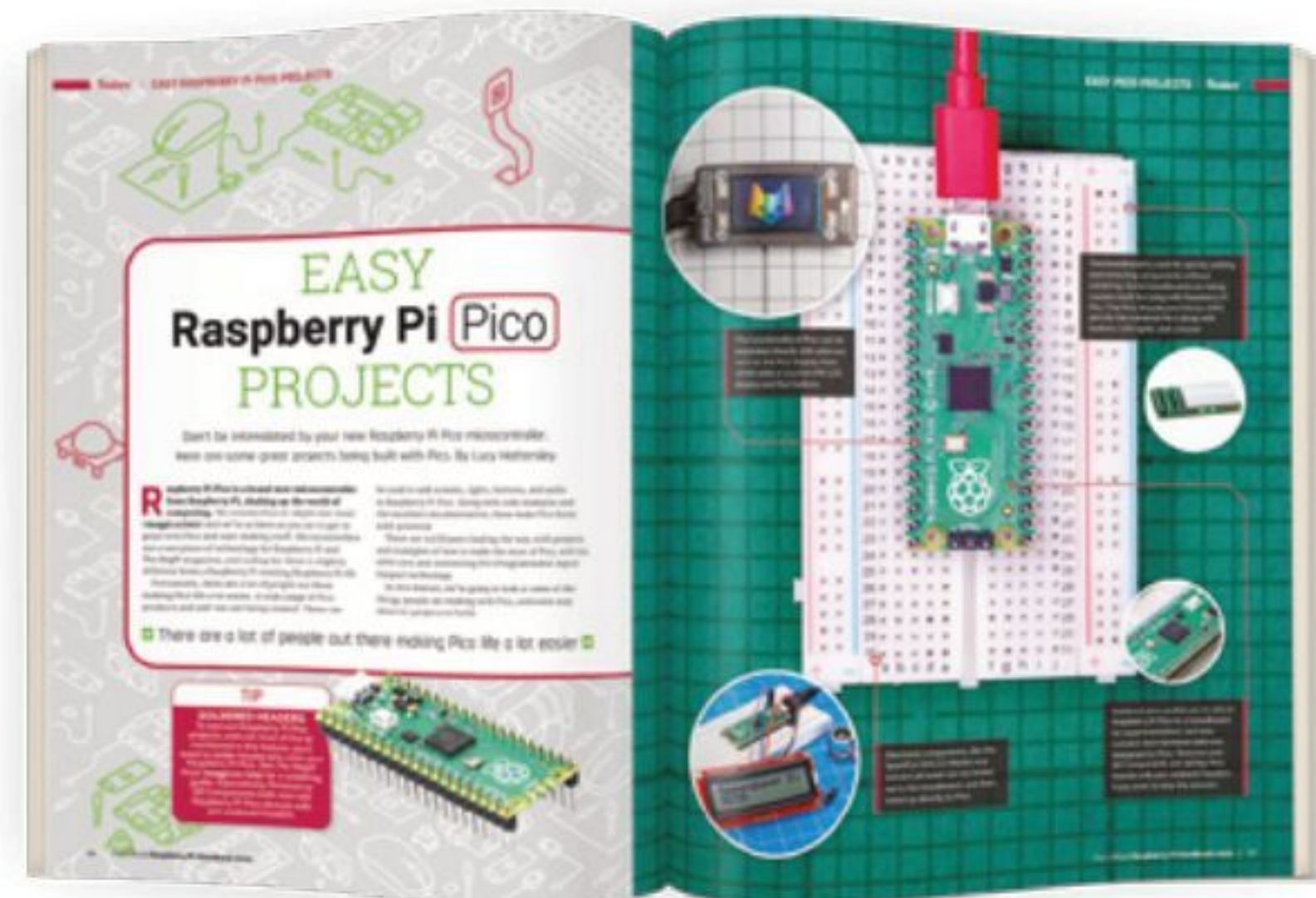
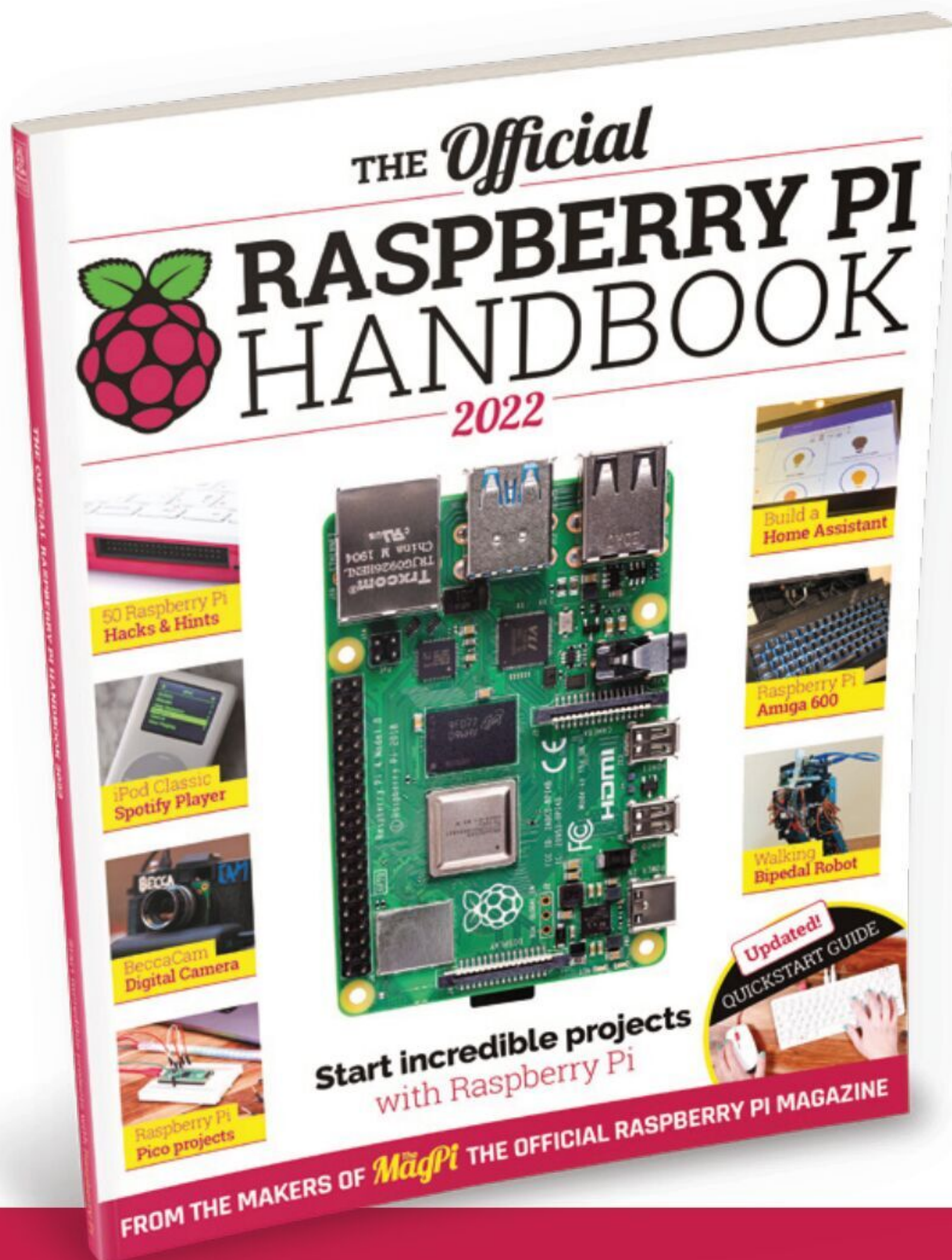

Buy online: magpi.cc/store

Pimoroni Inventor 2040 W (Pico W Aboard)

Making the Pico W plug-and-play

PIMORONI  £34.50 | pimoroni.com

By Ben Everard

 @ben_everard

Right 
The key information
is on the rear
silkscreen



Pimoroni's Pico W Aboard range of boards features something we've not seen before – a microcontroller development board soldered onto another board to provide a complete, out-the-box experience.

This isn't like the Shields, HATs, Wings, Capes, and other add-on boards that plug into development boards, because the Pico W comes pre-soldered on. This might seem like a ludicrous idea to anyone who remembers a time when microcontroller boards themselves were expensive bits of kit, but with Pico W clocking in at just \$6, it makes sense. After all, adding headers (pins for Pico W and socket for the board) would probably cost almost as much as the Pico W (no, we don't understand the economics of headers costing a significant fraction of a development board either).

This way, you get a compact, reliable board that's ready to go out of the box for a decent price – who are we to argue with that? We've been testing out one of the boards from the Pico W Aboard range: the Inventor 2040 W, which adds battery power, audio output, motor drivers, buttons, I2C breakouts, and twelve RGB LEDs.

The majority of the connections on the board – audio, the two motor connectors, and the two Qwiic / STEMMA connectors – require specific plugs in order to be able to connect to them (as opposed to pin headers that let you solder on almost anything). In many cases, this will be a good thing – it uses less space on the board, you can't wire things incorrectly, and you can get started without soldering. This also makes it very reusable. Hardware can be easily attached, but it can also

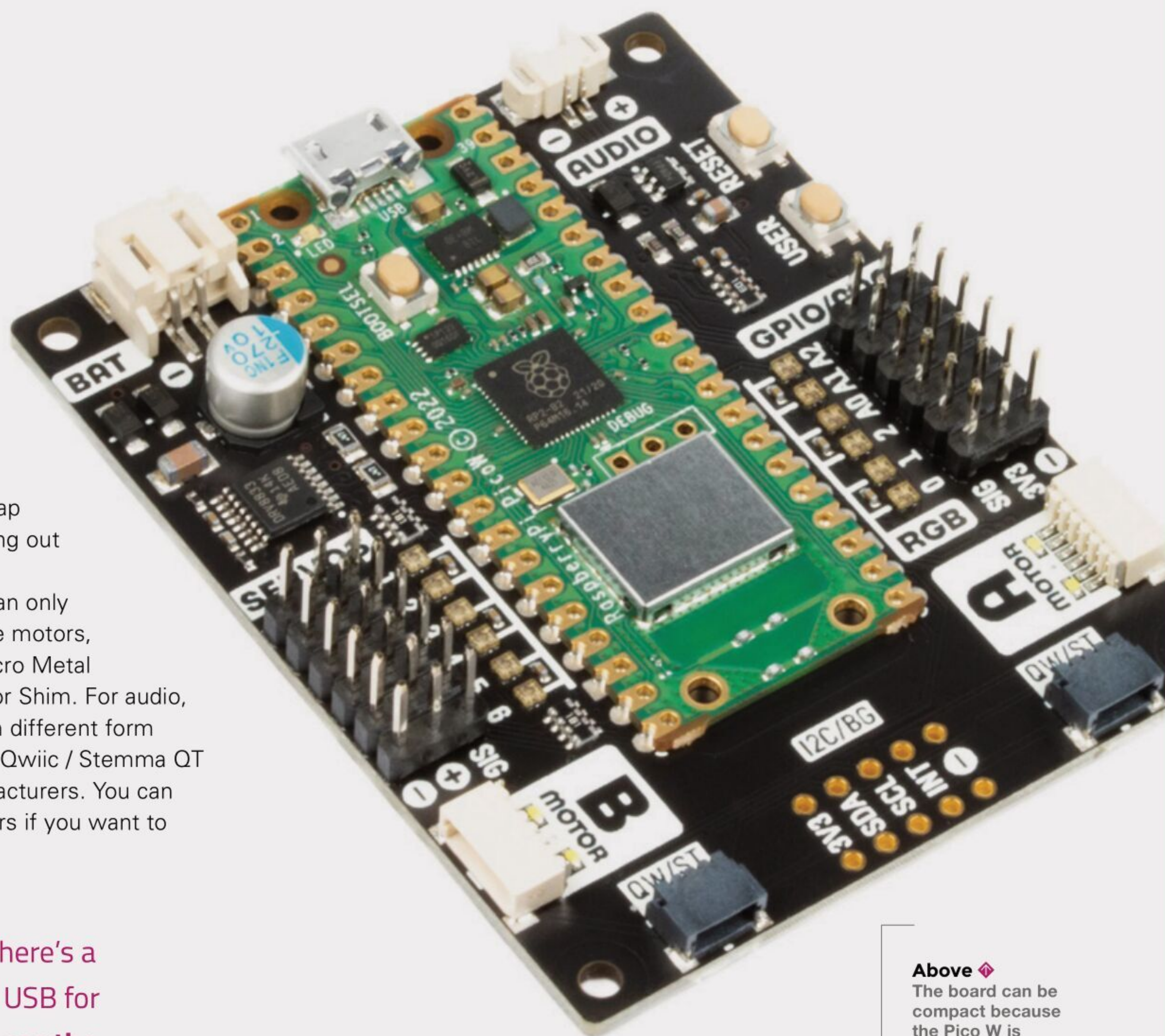

easily be removed should you want to use the board in a new project. At £34.50, it's not a cheap board, but this does take the sting out of the cost a little.

However, it also means you can only attach specific hardware. For the motors, there is a single option – the Micro Metal Gearmotor with Motor Connector Shim. For audio, Pimoroni does a few speakers in different form factors. There's a wide range of Qwiic / Stemma QT boards from a number of manufacturers. You can purchase the requisite connectors if you want to attach different hardware.

At the moment, there's a battery input and USB for power; you can't use the USB to charge the battery

With six servo connectors and two motors, this board is well placed for movement. This doesn't necessarily mean a wheeled robot (though the battery connector and two motors certainly allow this). Six servos are enough to give some quite complex movements, and with audio out as well, it could be a good choice for a Halloween decoration or advanced cosplay prop.

TAKING CARE

The thing we really like about this board is how it's laid out. It's obviously been done with care and by thinking about how potential users might use the board. For example, the motor ports are on opposite sides of the board, and in many robotic applications, you put the board between the motors. This makes the wiring less tangled which, in turn, makes debugging any problems easier. There are RGB LEDs next to each of the servo and GPIO pins – you can use these to show information about

the connected peripheral. There's 3.3V and GND connectors for each GPIO – after all, most things that you connect to a GPIO need either power or ground, and this makes it much easier to wire everything up.

One thing we'd really like to see on this board is battery charging. At the moment, there's a battery input and USB for power; you can't use the USB to charge the battery. This does come with an advantage that you can use a range of different batteries (such as AA packs) as well as LiPos, but it's 2022, aren't we all using LiPos for our battery-powered projects? Being able to charge directly through the board is so much easier than having to wiggle the battery connector out every time you need more power.

Finally, a word of praise for the silkscreen – the text printed on the PCB. Most PCBs have some text on to help guide the user, but the silkscreen on the Inventor 2040 W is done particularly well. By using different text treatments, it breaks up the information to allow a lot of detail to be put on, while still allowing it to be clear and easy to understand. □

Above ♦ The board can be compact because the Pico W is soldered on by machinery

VERDICT

Start building your robotics projects without having to solder.

9/10

FROM THE MAKERS OF *MagPi* THE OFFICIAL RASPBERRY PI MAGAZINE

NEW
2022
UPDATE

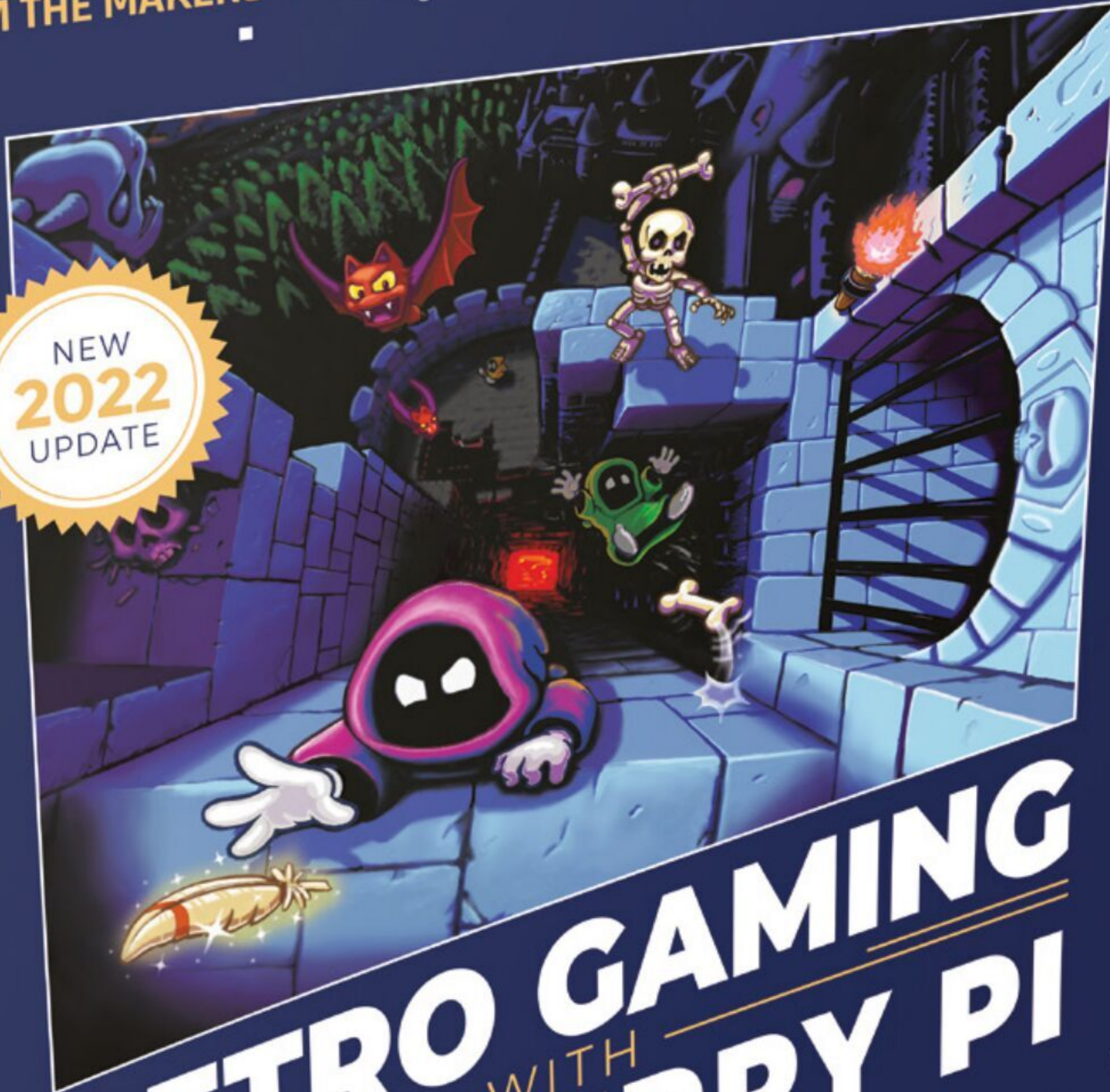

PLAY
& CODE
GAMES!

RETRO GAMING WITH RASPBERRY PI 2ND EDITION

164 PAGES OF
VIDEO GAME PROJECTS

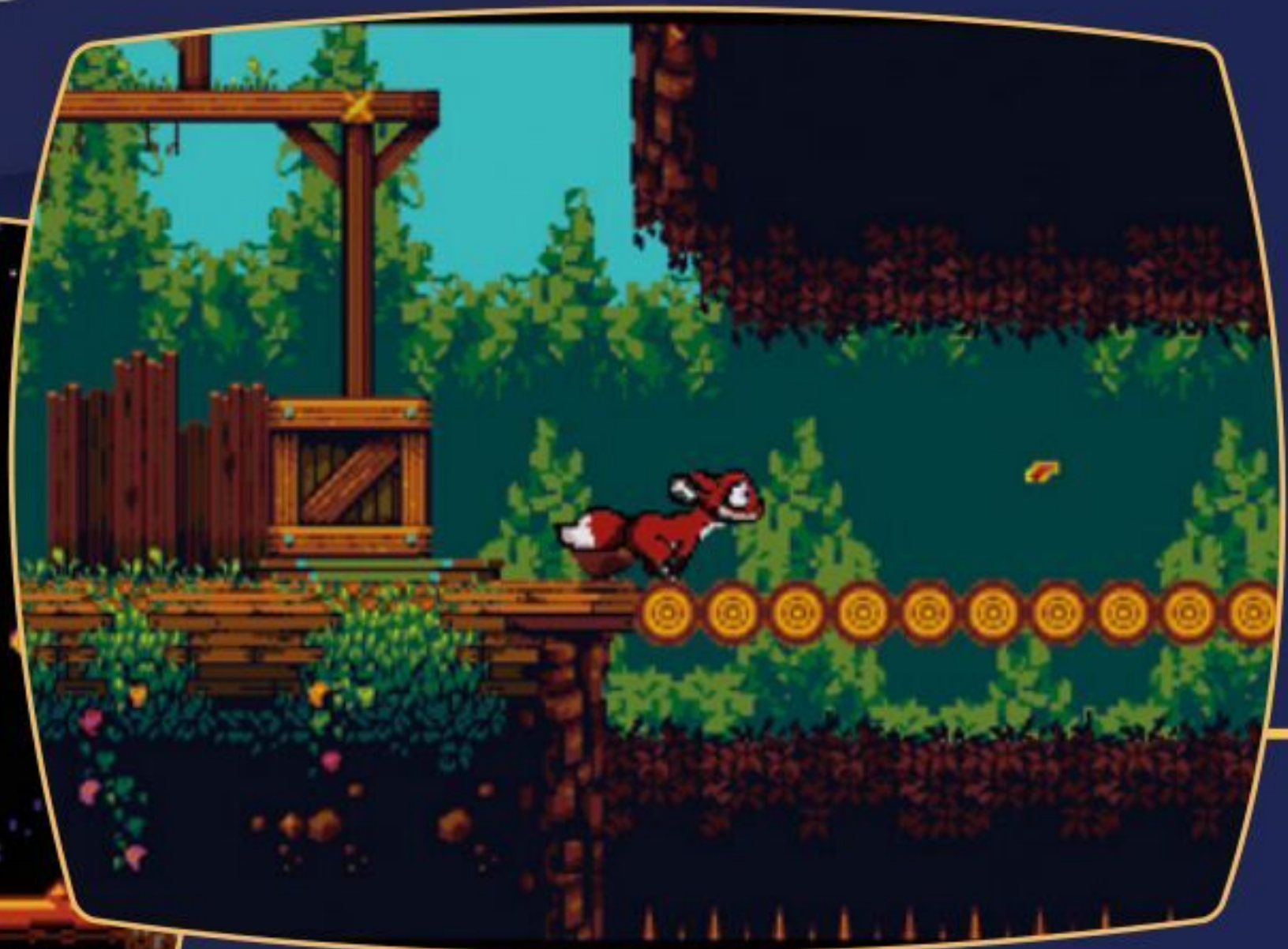

RETRO GAMING

WITH

RASPBERRY PI

2ND EDITION

Retro Gaming with Raspberry Pi shows you how to set up a Raspberry Pi to play classic games. Build your own games console or full-size arcade cabinet, install emulation software and download classic arcade games with our step-by-step guides. Want to make games? Learn how to code your own with Python and Pygame Zero.

- ***Set up Raspberry Pi for retro gaming***
- ***Emulate classic computers and consoles***
- ***Learn to code your own retro-style games***
- ***Build a console, handheld, and full-size arcade machine***



BUY ONLINE: magpi.cc/store

3 Coil Crane folding scalpel

Tuck your blades away when not in use

3 COIL ♦ £19.95 | heinnie.com/3-coil-crane

By Jo Hinchliffe

 @concreted0g

I can't imagine many days where I don't use a craft knife or scalpel as a maker, from weeding vinyl cuts to cutting card and balsa, not forgetting box opening; it's the everyday go-to tool. Craft knives and scalpels come in a wide range of shapes and sizes in both handle sections and blade choice – it's handy to have a selection set up for different tasks.

I'm a big fan of craft knives that can hide their blade. The X-ACTO knife is a classic design that doesn't stow its blade, but has a lid. They are excellent tools; however, one flaw is that the lids

often get removed if they're jostled around during transit. Another personal favourite is the Swann-Morton Retractable, which takes a variety of scalpel blade types and retracts them inside a neat metal body. It does, however, have a slight amount of blade play side to side, which means it might not be the tool I reach for if I'm attempting something that requires precision. Speaking of Swann-Morton, it used to make an excellent multifunction craft knife – the UNI-T – which had three foldaway blades but, sadly, this model has been discontinued.

Below ♦
Once open, the 3 Coil Crane feels secure in hand with the slip joint-style mechanism



The 3 Coil Crane folding scalpel caught my eye as it seemed to solve some of the problems the aforementioned choices have. At just under £20 and available in the UK from Heinnie Haynes – a knife/multitool and outdoor equipment retailer with a good record on customer service – it seemed worth a go. The unit arrived swiftly and was well-packed in a blister package – a blade was already fitted, and there was also a spare. The blades are standard No.11 scalpel blades; these are widely available online, so sourcing replacements is a breeze.

It's tiny! In the closed position, it measures just 5.2 cm long, which is useful in terms of not taking up much room in your kit-bag, but it's pretty easy to misplace. It's made from steel with a brushed finish and is constructed to a good standard. Opening the blade section, the blade clicks into the open position firmly – it doesn't have a locking mechanism, but rather, uses a slip joint approach to keep the blade open. As an aside, the small blade and the non-locking aspect of the 3 Coil Crane means that it is legal for UK carry.

Once open, the entire length is 9.4 cm, which is still pretty short compared to an X-ACTO knife or equivalent. It feels positive in the hand, though, and it can be held in a number of ways – I often grasp my scalpel with a pen grip. The 3 Coil Crane, despite its diminutive size, is great in use.

There was no blade play in the reviewed item, and the slip joint was quite tight. If it needs adjusting, you can

“ My main fear with this little knife is that I'll lose it! If it had a lanyard loop, it would be just about perfect ”

simply use a small Torx driver to adjust the tension of the pivot point. When closed with the supplied blade, there is absolutely no blade on display, and I would feel confident having it in my pocket or tool bag with no fear of accidents. To change the blade

– it mounts with the standard scalpel mount – you need to open it to around halfway, lift the rear of the blade above the mount, and push gently forward so that the blade slides off. As this is the standard size

scalpel mount, we tried numerous different scalpel blades on the frame. When open, it can be used with many different types of blade, but when you close the device with these alternate blades, you invariably end up with sharp sections of the blade exposed. However, if you are happy to swap back to a No.11 when you've finished, there is no reason you can't use alternate blades.

There's a lot to like with this little blade. If you look around for similar folding scalpels, you quickly see that its nearest competitors are at least twice the price. You will also find tactical titanium folding scalpel systems for hundreds of pounds. My main fear with this little knife is that I'll lose it! If it had a lanyard loop, it would be just about perfect. □



Above ♦ With the No.11 blade, the 3 Coil Crane closes with no part of the blade exposed and is tiny enough for the smallest pocket



Left ♦ The 3 Coil Crane arrives well packaged and with a fitted blade, plus one spare blade

VERDICT

A quality scalpel holder that uses No.11 blades safely and securely. Points deducted for only taking one style of blade, and for no lanyard hole!

8/10

issue

#59

ON SALE
22 SEPTEMBER

3D PRINTING

Also

- PICO W
- CIRCUITPYTHON
- LASER CUTTING
- ELECTRONICS
- AND MUCH MORE

DON'T MISS OUT

hsmag.cc/subscribe

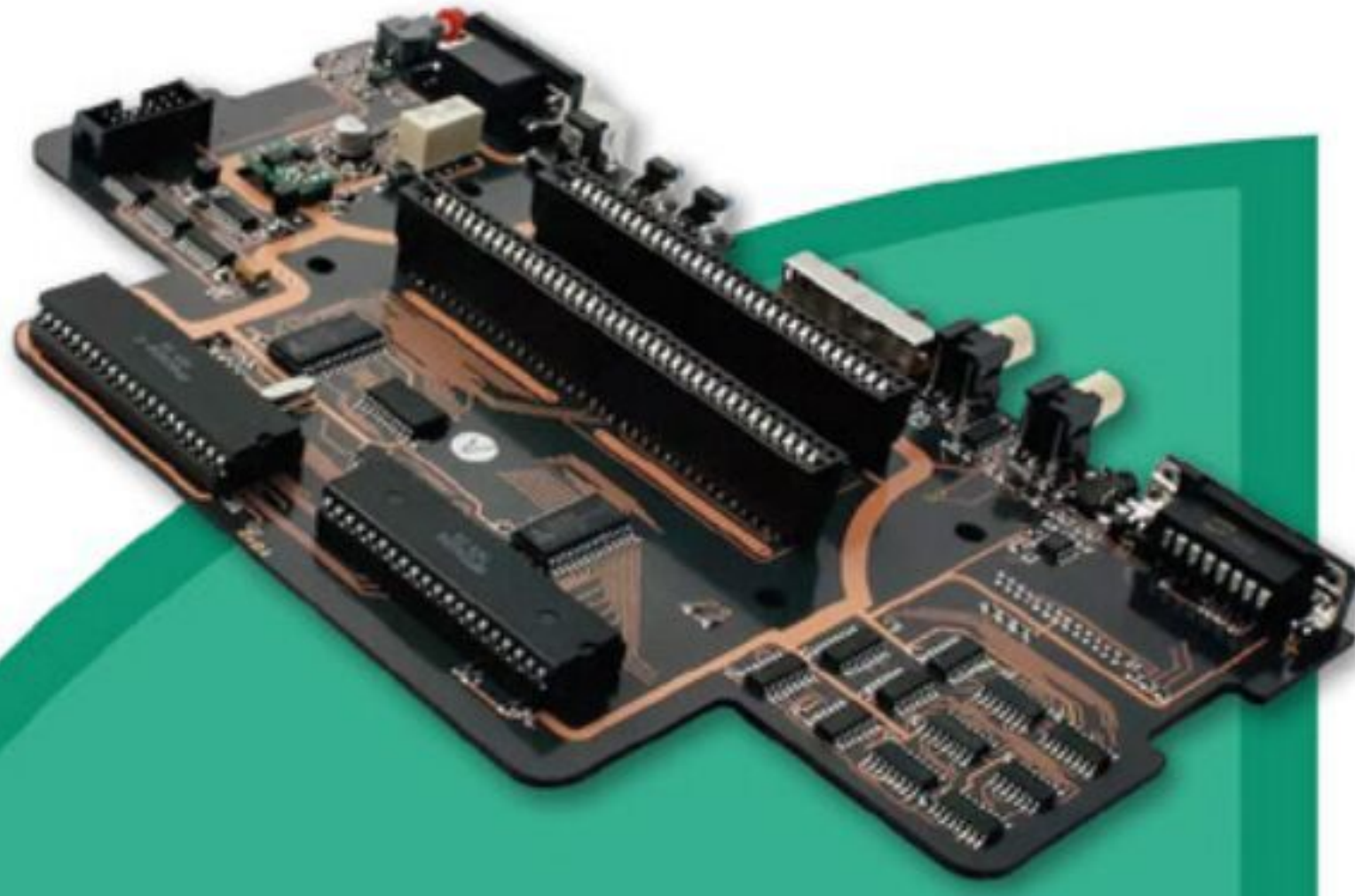

- High-Quality PCBA with component sourcing
- Start from only **\$30**
- Free stencil & Free shipping all over the world

Turnkey PCB Assembly

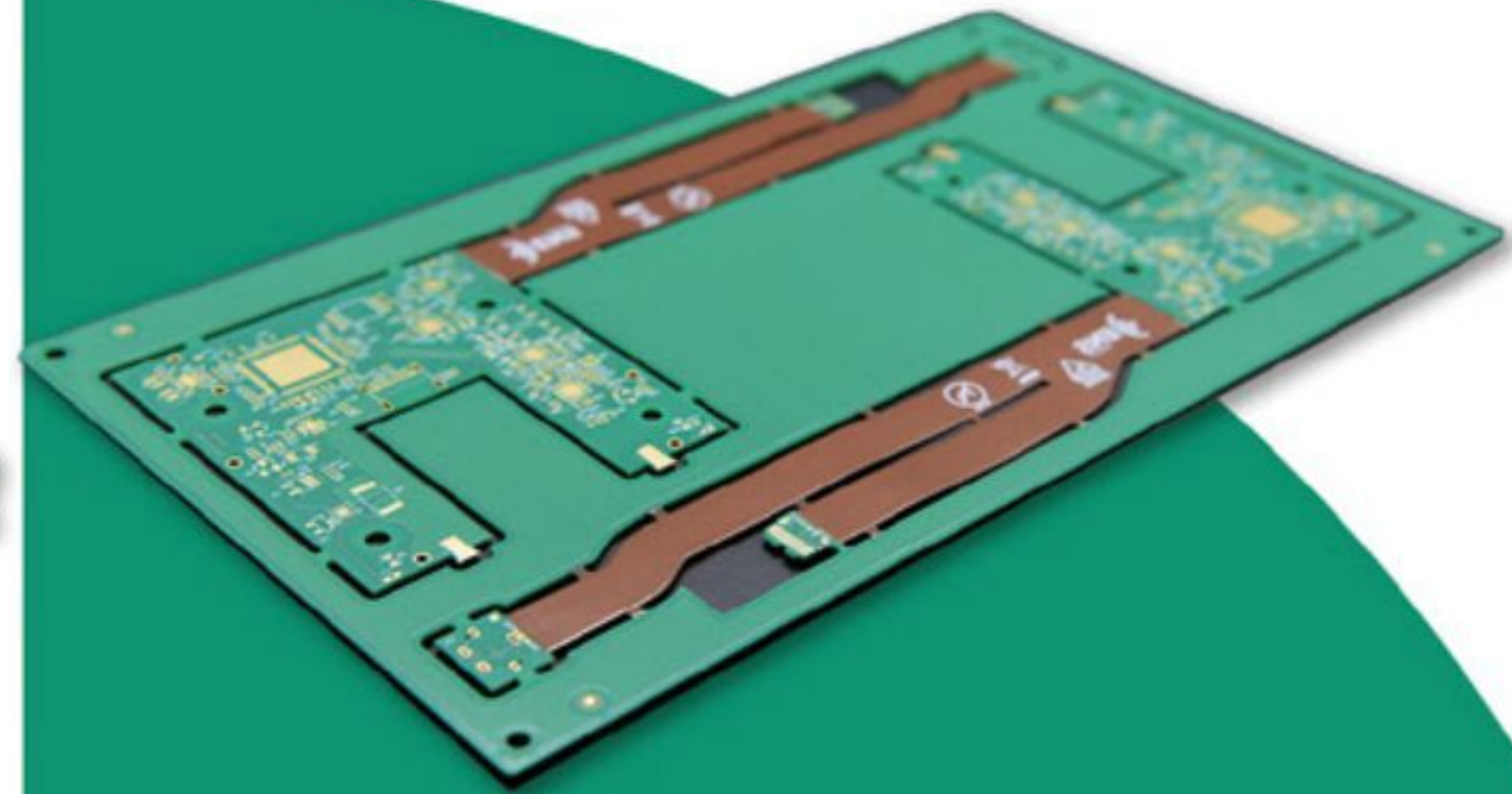

- Instant quote online & User-friendly web interface
- Fast turnaround in **24 hours**
- Make your unique and high-end products the easy way

Advanced PCB Fabrication

**Quality
Guaranteed**

3D Printing & CNC Machining

- Custom metal & plastic parts for **only \$25**
- On-demand production and rapid prototyping in **as fast as 1 day** leading the digital manufacturing revolution.



More Custom Options

- Professional Flex/Rigid-Flex PCB
- New soldermask colors: **Pink, Gray, Orange and Transparent**
- Perfectly implement your idea with different types of PCB



More information:
www.PCBWay.com

Email:
service@pcbway.com

Phone:
(0571) 8531 7603

PiKVM

Manage your servers or workstations remotely

A **cost-effective** solution for data-centers, IT departments or remote machines!



PiKVM HAT
for DIY and custom projects



Pre-Assembled version

- Real-time clock with rechargeable super capacitor
- OLED Display
- Bootable virtual CD-ROM & flash drive
- Serial console
- Open-source API & integration
- Open-source software

Available at the main Raspberry Pi resellers

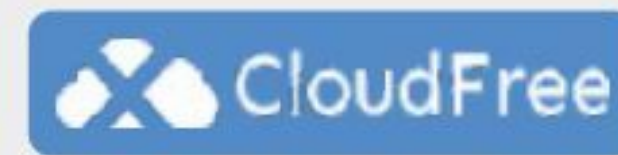

Reseller suggestions and inquiries:
wholesale@hipi.io